

勝特力材料 886-3-5753170
勝特力电子(上海) 86-21-54151736
勝特力电子(深圳) 86-755-83298787
[Http://www.100y.com.tw](http://www.100y.com.tw)

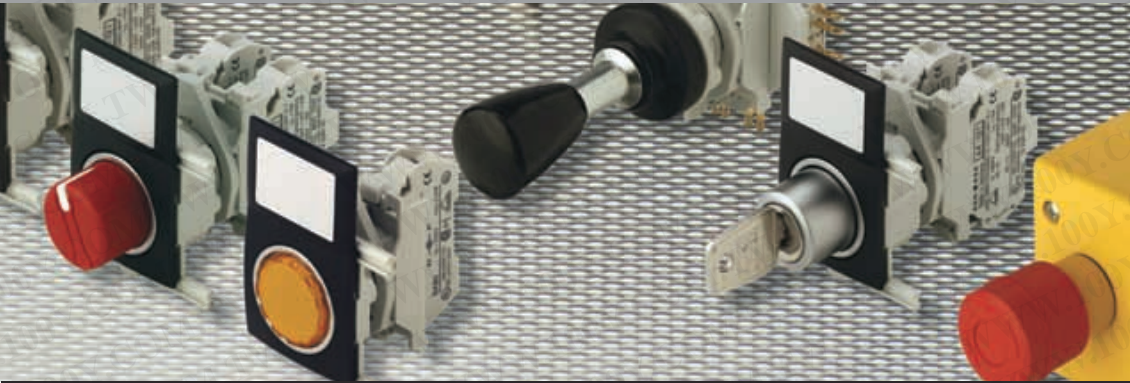

EAO Product Information

Series 44

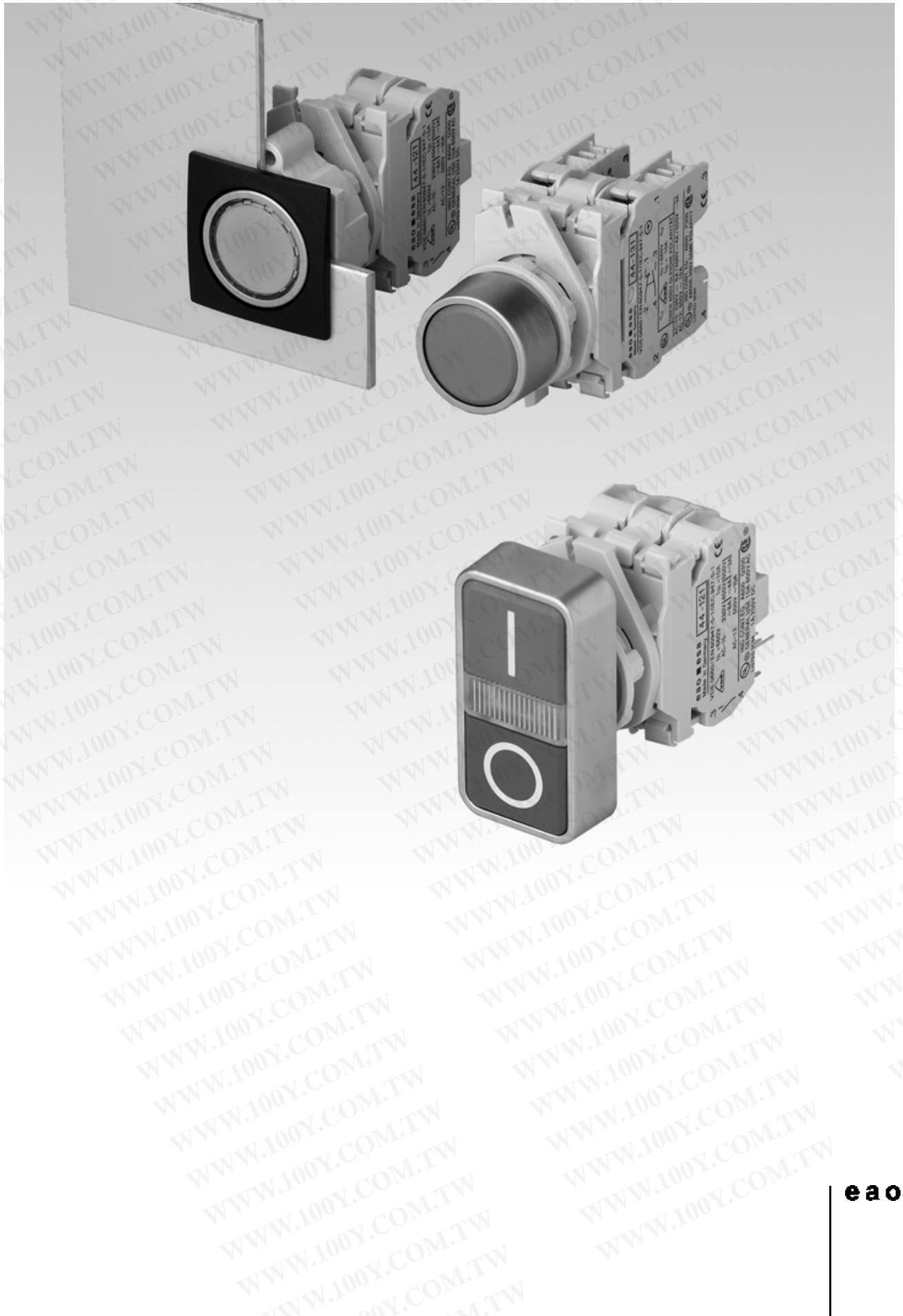

Index

Series 44

Description	Page 285
Product Assembly	Page 286
Mounting Instruction	Page 287
Product Range	
- pushbuttons complete	Page 289
- pushbuttons for standard mounting	Page 294
- pushbuttons for flush mounting	Page 310
- accessories / spare parts	Page 322
Technical Data	Page 332
Technical Drawing / Dimension	Page 334
Circuit Drawing	Page 348
Typical Applications	Page 354
Marking	Page 355

Description

CE

Series 44 is a high-quality product that has been manufactured and tested according to the most up-to-date international and national regulations and standards. Our products are marked with the CE sign in accordance with the directive for low voltages.

General notes

Series 44, a modular system of control units, offers the user numerous combinations with its wide range of actuator elements for pushbuttons, emergency-OFF pushbuttons, rotary and keylock switches, interlocking pushbuttons, potentiometer drives, illuminated pushbuttons and indicators. At the front the actuators feature an IP 65 protection class and can be supplied with matt grey or matt chrome front rings.

The switching elements can be supplied for fitting on front adapters or for fitting on base adapters, so that each control or indication point can be made to fit the requirements of the most varied conditions of usage, such as in industrial and mechanical engineering, marine and rail-vehicle construction, systems engineering and the construction of control mechanisms.

Design

The system consists of actuators, front or base adapters, switching elements, lamp elements, pre-switching elements and lamp transformers. The connection between the actuator elements and the various function elements is done by means of a latch click-stop connection through the front adapter for front attachment.

For base attachment the various function elements are click-stopped on to the base adapter.

For pushbuttons with front attachment, further switching elements in the 2nd level can be click-stopped on to the 1st level of switching elements (tandem arrangement).

Mounting

The control pushbuttons and indicators of Series 44 are designed to be fitted in a mounting hole of 22.5 mm diameter in accordance with IEC 947-5-1 and VDE 0660. The actuators can be inserted in mounting holes with or without recess for the anti-twisting device and are self-holding which means that they can be fitted quickly and easily in the front panel (one-person fitting).

For details of mounting and dismantling see page 287.

Keylock switches

Standard lock with integrated cap. 1 standard number 9500. Without specifications for the lock number we supply standard number 9500. For locks with defined lock number, add after the type number (code 01-10). Further lock numbers on request. Two keys are supplied for each keylock switch.

Spare keys can be ordered under Type No. 44-919 (provided the lock number is quoted).

Protection provisions

When the actuator elements are installed in metallic front panels and housings, they should not be incorporated in the protection provision. When installed in insulated housing, the "protection insulation" provision is preserved.

Terminals

All function elements have shockproof screw terminals (finger safety in accordance with DIN/VDE 0106, part 100 and VBG 4) and have openings to guide a screwdriver. When delivered, the screw terminals are open, thus guaranteeing safe and fast installation.

The lamp transformer has screw terminals as primary-terminal and as secondary connection connecting leads with multi-core cable ends. The designation for terminal connections accords with DIN EN 50013.

Connection cross-sections: single core - 0.50 mm² to 2.5 mm²
 multiple core - 0.75 mm² to 1.5 mm²
 multiple core with multi-core cable ends - 0.50 mm² to 1.5 mm²

Marking

The marking plate for illuminated pushbuttons, indicators or markable pushbuttons can be provided with pictograms conforming to ISO-R 369 or with lettering. (See page 355.).

Illumination

Incandescent lamps, neon lamps or light-emitting diodes (multi-LEDs) with Ba9s lampholder assure perfect illumination of the indicators and illuminated pushbuttons.

Supply

The units are supplied as single components.

Specimen order

Indicator front mounting

- actuator plastic matt chrome, red	1 x 44-750.22
- front adapter	1 x 44-900
- lamp element	1 x 44-524
- incandescent lamp 6 V	1 x 10-1406.1369

All dimensions in mm

All rights are reserved to make changes to technical data.

illuminated pushbutton / front mounting

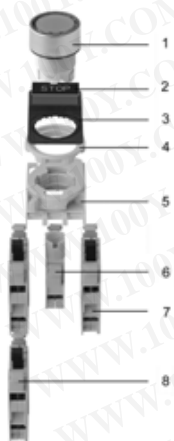

- 1 actuator
- 2 label for label support
- 3 label support
- 4 fixing nut
- 5 front adapter
- 6 lamp element
- 7 switching element 1. level
- 8 switching element 2. level

illuminated pushbutton for flush mounting / front mounting

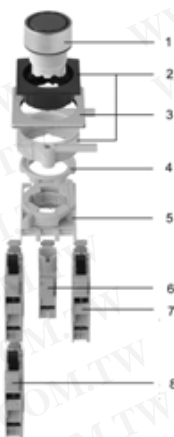

- 1 actuator
- 2 front bezel-set for flush mounting
- 3 front panel
- 4 fixing nut
- 5 front adapter
- 6 lamp element
- 7 switching element 1. level
- 8 switching element 2. level

illuminated pushbutton / base mounting (separated mounting)

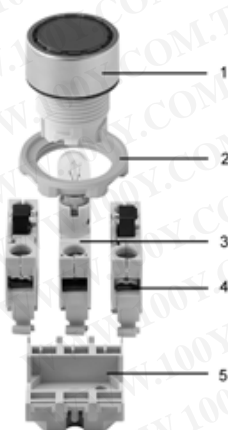

- 1 actuator
- 2 fixing nut
- 3 lamp element
- 4 switching element
- 5 base adaptor

Switching element

Dismantling a switching element with a screwdriver

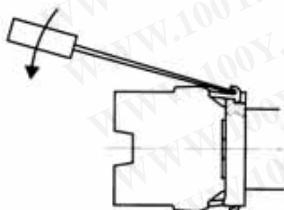

To dismantle switching elements, lamp elements or lamp transformer, slightly lift the latching arm with the tip of a screwdriver.

Lamp transformer

Methods of mounting on base adaptor

on front adaptor

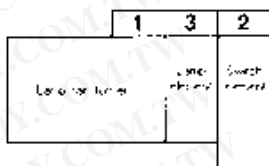
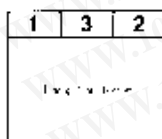
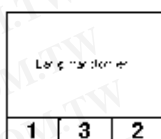

Housing

Tip for mounting:

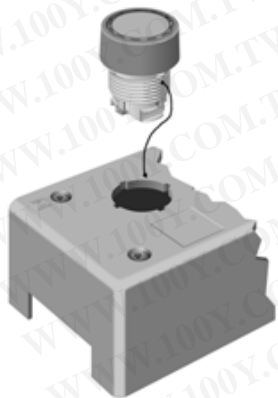

Mount the actuator so that the anti-rotation lug faces the square area next to the mounting hole.

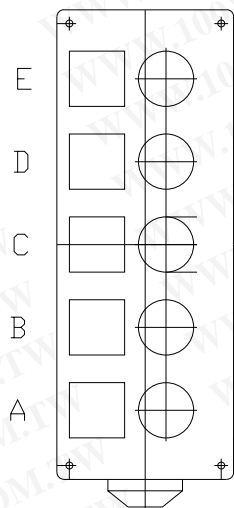

Base adaptors are included in the housing.

In the ends of the housing are cable entries 22.5 mm dia., fitted with an inlet grommet at one end.

A second grommet is supplied in the housing.

In addition, a special screw gland M20 can be supplied (see spare parts and accessories)

Opening designations

A, B, C, D and E

Opening A is nearest to the inlet grommet

indicator complete full face illumination not for marking



🛒 filament lamp page 329

🛒 LED page 329

	front ring	colour of lens	28.2 mm dia. Typ-Nr.	circuit drawing	technical drawing	mounting dimensions	
indicator complete full face illumination not for marking	plastic matt chrome	colourless, clear	44-750.27.000	1	1	1	0,025
		yellow	44-750.24.000	1	1	1	0,025
		green	44-750.25.000	1	1	1	0,025
		red	44-750.22.000	1	1	1	0,025

circuit drawings from page 348, technical drawings from page 334, mounting dimensions from page 347

indicator complete front illumination for marking



🛒 filament lamp page 329

🛒 LED page 329

	front ring	colour of lens	28.2 mm dia. Typ-Nr.	circuit drawing	technical drawing	mounting dimensions	
indicator complete front illumination for marking with text plate translucent white	plastic matt chrome	yellow	44-751.24.000	1	1	1	0,025
		green	44-751.25.000	1	1	1	0,025
		red	44-751.22.000	1	1	1	0,025
		white	44-751.29.000	1	1	1	0,025

circuit drawings from page 348, technical drawings from page 334, mounting dimensions from page 347

pushbutton complete





	switching action	contacts	front ring	colour of lens	28.2 mm dia. Typ-Nr.	circuit drawing	technical drawing	mounting dimensions	
pushbutton complete	momentary action	1 NO	plastic matt chrome	yellow	44-701.24.010	4	2	1	0,030
				green	44-701.25.010	4	2	1	0,030
				white	44-701.29.010	4	2	1	0,030
	maintained action	1 NC + 1 NO	plastic matt chrome	red	44-701.22.001	3	2	1	0,030
				black	44-701.20.100	2	2	1	0,037
				1 NO	plastic matt chrome	green	44-702.25.010	6	2
				black	44-702.20.100	5	2	1	0,037

contacts : normally closed = NC, normally open = NO, 1 normally closed = 1 NC, 1 normally open = 1 NO
 circuit drawings from page 348, technical drawings from page 334, mounting dimensions from page 347

illuminated pushbutton complete for marking



-  filament lamp page 329
-  LED page 329

	switching action	contacts	front ring	colour of lens	28.2 mm dia. Typ-Nr.	circuit drawing	technical drawing	mounting dimensions			
illuminated pushbutton complete for marking	momentary action	1 NO	plastic matt chrome	yellow	44-746.24.010	8	3	1	0,040		
				green	44-746.25.010	8	3	1	0,040		
				red	44-746.22.001	7	3	1	0,040		
	maintained action	1 NC + 1 NO	plastic matt chrome	white	44-746.29.100	9	3	1	0,047		
				1 NO	plastic matt chrome	green	44-747.25.010	10	3	1	0,040
						white	44-747.29.100	11	3	1	0,047

contacts : 1 normally closed = 1 NC, 1 normally open = 1 NO, normally closed = NC, normally open = NO
 circuit drawings from page 348, technical drawings from page 334, mounting dimensions from page 347

emergency stop switch complete



	unlocking	switching action	contacts	50 mm dia. Typ-Nr.	37 mm dia. Typ-Nr.	circuit drawing	technical drawing	mounting dimensions	
emergency stop switch complete red mushroom-head cap, yellow shaft	twist to release	MA	1 NC	44-710.001		12	4	2	0,057
foolproof, red mushroom-head cap, yellow shaft standard lock 9500	twist to release	MA	1 NC		44-712.001	12	5	2	0,047
	key to release	MA	1 NC		44-713.001	12	5	2	0,083

switching action : maintained action = MA

contacts : 1 normally closed = 1 NC

circuit drawings from page 348, technical drawings from page 334, mounting dimensions from page 347

key lock complete 2 positions



	switching action	contacts	key removable in	front ring	28.2 mm dia. Typ-Nr.	circuit drawing	technical drawing	mounting dimensions	
key lock complete 2 positions position 0: basic position position I: maintained action standard lock 9500	MA	1 NC + 1 NO	0	plastic matt chrome	44-730.21.100	13	6	1	0,075
			0-I	plastic matt chrome	44-730.22.100	13	6	1	0,075

switching action : maintained action = MA

contacts : normally closed = NC, normally open = NO

circuit drawings from page 348, technical drawings from page 334, mounting dimensions from page 347

key lock complete 3 positions



	switching action	contacts	key removable in	front ring	28.2 mm dia. Typ-Nr.	circuit drawing	technical drawing	mounting dimensions	
key lock complete 3 positions position 0: basic position position I + II: maintained action standard lock 9500	maintained - 0 - maintained	2 NO	I-0-II	plastic matt chrome	44-734.25.020	14	7	1	0,078

switching action

contacts : normally open = NO

circuit drawings from page 348, technical drawings from page 334, mounting dimensions from page 347

selector switch complete 2 positions



	switching action	contacts	lever	front ring	28.2 mm dia. Typ-Nr.	circuit drawing	technical drawing	mounting dimensions	
selector switch complete 2 positions position 0: basic position position I: maintained action	MA	1 NC + 1 NO	black	plastic matt chrome	44-720.20.100	15	8	1	0,045

switching action : maintained action = MA

contacts : normally closed = NC, normally open = NO

circuit drawings from page 348, technical drawings from page 334, mounting dimensions from page 347

selector switch complete 3 positions



	switching action	contacts	lever	front ring	28.2 mm dia. Typ-Nr.	circuit drawing	technical drawing	mounting dimensions	
selector switch complete 3 positions position 0: basic position position I + II: maintained action	maintained - 0 - maintained	1 NO + 1 NO	black	plastic matt chrome	44-724.20.020	16	9	1	0,048

switching action : maintained action = MA

contacts : normally open = NO

circuit drawings from page 348, technical drawings from page 334, mounting dimensions from page 347

control switch

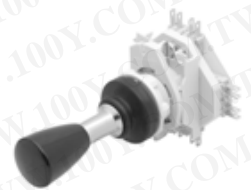

	Funciothn	Contacts	Color of Operating part	Ø 22,5 mm Typ-Nr.	
Control Switch 2 positions without latch positon	I	2x 1 NC + 1 NO	black	44-800.2	0,048
Control Switch 4 positions without latch positon	I	4x 1 NC + 1 NO	black	44-800.4	0,048
Control Switch 8 positions without latch positon without lever guidance (omni directional)	I	4x 1 NC + 1 NO	black	44-800.8	0,048

indicator actuator, full face illumination not for marking



- ☞ filament lamp page 329
- ☞ LED page 329
- ☞ front adapter page 327
- ☞ lamp element for front mounting page 328
- ☞ base adaptor page 328
- ☞ lamp for base mounting page 329

	front ring	colour of lens	28.2 mm dia. Typ-Nr.	technical drawing	mounting dimensions	
indicator actuator, full face illumination not for marking	plastic matt grey	blue	44-750.66	10	1	0,008
		colourless, clear	44-750.67	10	1	0,008
		yellow	44-750.64	10	1	0,008
		green	44-750.65	10	1	0,008
		red	44-750.62	10	1	0,008
	plastic matt chrome	blue	44-750.26	10	1	0,008
		colourless, clear	44-750.27	10	1	0,008
		yellow	44-750.24	10	1	0,008
		green	44-750.25	10	1	0,008
		red	44-750.22	10	1	0,008

technical drawings from page 334, mounting dimensions from page 347

indicator actuator, front illumination for flush mounting for marking



- 🛒 filament lamp page 329
- 🛒 LED page 329
- 🛒 front adapter page 327
- 🛒 lamp element for front mounting page 328
- 🛒 base adaptor page 328
- 🛒 lamp for base mounting page 329

	front ring	colour of lens	28.2 mm dia. Typ-Nr.	technical drawing mounting dimensions		
indicator actuator, front illumination for flush mounting for marking	plastic matt grey	blue	44-751.66	11	1	0,007
		yellow	44-751.64	11	1	0,007
		green	44-751.65	11	1	0,007
		red	44-751.62	11	1	0,007
		white	44-751.69	11	1	0,007
	plastic matt chrome	blue	44-751.26	11	1	0,007
		yellow	44-751.24	11	1	0,007
		green	44-751.25	11	1	0,007
		red	44-751.22	11	1	0,007
		white	44-751.29	11	1	0,007

technical drawings from page 334, mounting dimensions from page 347

pushbutton actuator not for marking



- ☞ front adapter page 327
- ☞ slow-make switching element stackable for front mounting page 327
- ☞ slow-make switching element not stackable for front mounting page 328
- ☞ base adaptor page 328
- ☞ slow-make switching element not stackable for base mounting page 328

	construction	switching action	front ring	colour of lens	28.2 mm dia. Typ-Nr.	circuit drawing	technical drawing	mounting dimensions	(E-3)
pushbutton actuator not for marking	front ring flush	M	plastic matt grey	blue	44-701.66	17	12	1	0,013
				yellow	44-701.64	17	12	1	0,013
				green	44-701.65	17	12	1	0,013
				red	44-701.62	17	12	1	0,013
				black	44-701.60	17	12	1	0,013
				white	44-701.69	17	12	1	0,013
			plastic matt chrome	blue	44-701.26	17	12	1	0,013
				yellow	44-701.24	17	12	1	0,013
				green	44-701.25	17	12	1	0,013
				red	44-701.22	17	12	1	0,013
				black	44-701.20	17	12	1	0,013
				white	44-701.29	17	12	1	0,013
	front ring raised	M	plastic matt grey	blue	44-703.66	17	12	1	0,015
				yellow	44-703.64	17	12	1	0,015
				green	44-703.65	17	12	1	0,015
				red	44-703.62	17	12	1	0,015
				black	44-703.60	17	12	1	0,015
				white	44-703.69	17	12	1	0,015
			plastic matt chrome	blue	44-703.26	17	12	1	0,015
				yellow	44-703.24	17	12	1	0,015
				green	44-703.25	17	12	1	0,015
				red	44-703.22	17	12	1	0,015
				black	44-703.20	17	12	1	0,015
				white	44-703.29	17	12	1	0,015
with knob high	M	plastic matt grey	blue	44-704.66	17	12	1	0,015	
			yellow	44-704.64	17	12	1	0,015	
			green	44-704.65	17	12	1	0,015	
			red	44-704.62	17	12	1	0,015	
			black	44-704.60	17	12	1	0,015	
			white	44-704.69	17	12	1	0,015	
		plastic matt chrome	blue	44-704.26	17	12	1	0,015	
			yellow	44-704.24	17	12	1	0,015	
			green	44-704.25	17	12	1	0,015	
			red	44-704.22	17	12	1	0,015	
			black	44-704.20	17	12	1	0,015	
			white	44-704.29	17	12	1	0,015	

Continued on next page

	construction	switching action	front ring	colour of lens	28.2 mm dia. Typ-Nr.	circuit drawing	technical drawing	mounting dimensions			
up to 3 switching elements max.	front ring flush	MA	plastic matt grey	blue	44-702.66	18	12	1	0,013		
				yellow	44-702.64	18	12	1	0,013		
				green	44-702.65	18	12	1	0,013		
				red	44-702.62	18	12	1	0,013		
				black	44-702.60	18	12	1	0,013		
				white	44-702.69	18	12	1	0,013		
				plastic matt chrome	blue	44-702.26	18	12	1	0,013	
			yellow	44-702.24	18	12	1	0,013			
			green	44-702.25	18	12	1	0,013			
			red	44-702.22	18	12	1	0,013			
			black	44-702.20	18	12	1	0,013			
			white	44-702.29	18	12	1	0,013			
			front ring raised	MA	plastic matt grey	blue	44-705.66	18	12	1	0,015
						yellow	44-705.64	18	12	1	0,015
	green	44-705.65				18	12	1	0,015		
	red	44-705.62				18	12	1	0,015		
	black	44-705.60				18	12	1	0,015		
	white	44-705.69				18	12	1	0,015		
	plastic matt chrome	blue				44-705.26	18	12	1	0,015	
	yellow	44-705.24			18	12	1	0,015			
	green	44-705.25			18	12	1	0,015			
	red	44-705.22			18	12	1	0,015			
	black	44-705.20			18	12	1	0,015			
	white	44-705.29			18	12	1	0,015			
	with knob high	MA			plastic matt grey	blue	44-706.66	18	12	1	0,015
						yellow	44-706.64	18	12	1	0,015
			green	44-706.65		18	12	1	0,015		
red			44-706.62	18		12	1	0,015			
black			44-706.60	18		12	1	0,015			
white			44-706.69	18		12	1	0,015			
plastic matt chrome			blue	44-706.26		18	12	1	0,015		
yellow			44-706.24	18	12	1	0,015				
green			44-706.25	18	12	1	0,015				
red			44-706.22	18	12	1	0,015				
black			44-706.20	18	12	1	0,015				
white			44-706.29	18	12	1	0,015				

switching action : momentary action = M, maintained action = MA

circuit drawings from page 348, technical drawings from page 334, mounting dimensions from page 347

pushbutton actuator for marking

colour of lens is determined by the colour of text plate



- 🛒 marking plate page 322
- 🛒 front adapter page 327
- 🛒 slow-make switching element stackable for front mounting page 327
- 🛒 slow-make switching element not stackable for front mounting page 328
- 🛒 base adaptor page 328
- 🛒 slow-make switching element not stackable for base mounting page 328

	switching action	front ring	colour of lens	28.2 mm dia. Typ-Nr.	circuit drawing	technical drawing	mounting dimensions	
pushbutton actuator for marking	M	plastic matt grey	clear	44-701.67	17	13	1	0,012
		plastic matt chrome	clear	44-701.27	17	13	1	0,012
up to 3 switching elements max.	MA	plastic matt grey	clear	44-702.67	18	13	1	0,012
		plastic matt chrome	clear	44-702.27	18	13	1	0,012

switching action : momentary action = M, maintained action = MA

circuit drawings from page 348, technical drawings from page 334, mounting dimensions from page 347

illuminated pushbutton actuator for marking



- 🛒 filament lamp page 329
- 🛒 LED page 329
- 🛒 front adapter page 327
- 🛒 slow-make switching element stackable for front mounting page 327
- 🛒 slow-make switching element not stackable for front mounting page 328
- 🛒 lamp element for front mounting page 328
- 🛒 base adaptor page 328
- 🛒 slow-make switching element not stackable for base mounting page 328
- 🛒 lamp for base mounting page 329

	switching action	front ring	colour of lens	28.2 mm dia. Typ-Nr.	circuit drawing	technical drawing	mounting dimensions	100Y
illuminated pushbutton actuator for marking	M	plastic matt grey	blue	44-746.66	19	14	1	0,012
			yellow	44-746.64	19	14	1	0,012
			green	44-746.65	19	14	1	0,012
			red	44-746.62	19	14	1	0,012
			white	44-746.69	19	14	1	0,012
		plastic matt chrome	blue	44-746.26	19	14	1	0,012
			yellow	44-746.24	19	14	1	0,012
			green	44-746.25	19	14	1	0,012
			red	44-746.22	19	14	1	0,012
			white	44-746.29	19	14	1	0,012
with text plate translucent white, up to max. 3 switching elements	MA	plastic matt grey	blue	44-747.66	20	14	1	0,012
			yellow	44-747.64	20	14	1	0,012
			green	44-747.65	20	14	1	0,012
			red	44-747.62	20	14	1	0,012
			white	44-747.69	20	14	1	0,012
		plastic matt chrome	blue	44-747.26	20	14	1	0,012
			yellow	44-747.24	20	14	1	0,012
			green	44-747.25	20	14	1	0,012
			red	44-747.22	20	14	1	0,012
			white	44-747.29	20	14	1	0,012

switching action : momentary action = M, maintained action = MA

circuit drawings from page 348, technical drawings from page 334, mounting dimensions from page 347

double pushbutton actuator



- 🛒 filament lamp page 329
- 🛒 LED page 329
- 🛒 front adapter page 327
- 🛒 slow-make switching element stackable for front mounting page 327
- 🛒 slow-make switching element not stackable for front mounting page 328
- 🛒 lamp element for front mounting page 328
- 🛒 base adaptor page 328
- 🛒 slow-make switching element not stackable for base mounting page 328
- 🛒 lamp for base mounting page 329

	switching action	marking	front bezel	colour of lens	□ 29.5 x 56 mm Typ-Nr.	technical drawing		
						mounting dimensions		
double pushbutton actuator	M	I + 0	plastic matt grey	green + red	44-771.6	15	3	0,018
			plastic matt chrome	green + red	44-771.2	15	3	0,018
	without		plastic matt grey	green + red	44-770.6	15	3	0,018
			plastic matt chrome	green + red	44-770.2	15	3	0,018

switching action : momentary action = M

technical drawings from page 334, mounting dimensions from page 347

Arrangement of switching element corresponds to the designation of the front adaptor

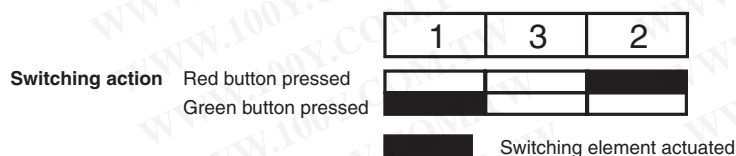

emergency stop switch actuator

up to 3 switching elements max. in 1. level



- 🛒 label for emergency stop switch page 331
- 🛒 front adapter page 327
- 🛒 slow-make switching element stackable for front mounting page 327
- 🛒 slow-make switching element not stackable for front mounting page 328
- 🛒 base adaptor page 328
- 🛒 slow-make switching element not stackable for base mounting page 328

	unlocking	switching action	37 mm dia. Typ-Nr.	50 mm dia. Typ-Nr.	circuit drawing	technical drawing	mounting dimensions	
emergency stop switch actuator	twist to release	MA	44-711		21	16	2	0,035
				44-710	21	16	2	0,040

switching action : maintained action = MA

circuit drawings from page 348, technical drawings from page 334, mounting dimensions from page 347

emergency stop switch actuator foolproof

up to 3 switching elements max. in 1. level

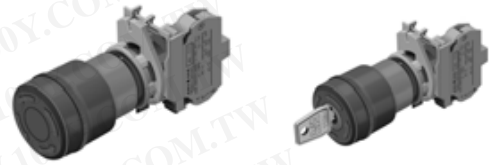

- 🛒 label for emergency stop switch page 331
- 🛒 front adapter page 327
- 🛒 slow-make switching element stackable for front mounting page 327
- 🛒 slow-make switching element not stackable for front mounting page 328
- 🛒 base adaptor page 328
- 🛒 slow-make switching element not stackable for base mounting page 328

	unlocking	switching action	37 mm dia. Typ-Nr.	circuit drawing	technical drawing	mounting dimensions	
emergency stop switch actuator foolproof	twist to release	MA	44-712	21	17	2	0,040
as per EN 418, red mushroom-head cap, yellow shaft, unlocking in direction of arrow, standard lock 9500, other lock numbers on request	key to release	MA	44-713	21	17	2	0,066

switching action : maintained action = MA

circuit drawings from page 348, technical drawings from page 334, mounting dimensions from page 347

pushbutton actuator with mushroom-head cap



- 🛒 front adapter page 327
- 🛒 slow-make switching element stackable for front mounting page 327
- 🛒 slow-make switching element not stackable for front mounting page 328
- 🛒 base adaptor page 328
- 🛒 slow-make switching element not stackable for base mounting page 328

	switching action			50 mm dia. Typ-Nr.	circuit drawing	technical drawing	mounting dimensions	
pushbutton actuator with mushroom-head cap	M	front ring	colour of mushroom-head cap					
		plastic matt grey	green	44-707.65	17	18	2	0,028
			red	44-707.62	17	18	2	0,028
			black	44-707.60	17	18	2	0,028
		plastic matt chrome	green	44-707.25	17	18	2	0,028
			red	44-707.22	17	18	2	0,028
		black	44-707.20	17	18	2	0,028	

switching action : momentary action = M

circuit drawings from page 348, technical drawings from page 334, mounting dimensions from page 347

keylock switch actuator 2 positions

up to 3 switching elements max. in 1. level



- 🛒 front adapter page 327
- 🛒 slow-make switching element stackable for front mounting page 327
- 🛒 slow-make switching element not stackable for front mounting page 328
- 🛒 base adaptor page 328
- 🛒 slow-make switching element not stackable for base mounting page 328

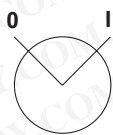

	switching action	key removable in	front ring	28.2 mm dia. Typ-Nr.	circuit drawing	technical drawing	mounting dimensions	
keylock switch actuator 2 positions	M	0	plastic matt grey	44-732.61	23	19	1	0,051
			plastic matt chrome	44-732.21	23	19	1	0,051
position 0: basic position position I: maintained action 90° standard lock 9500 other lock numbers on request	MA	0	plastic matt grey	44-730.61	22	19	1	0,051
			plastic matt chrome	44-730.21	22	19	1	0,051
	0 + I	0	plastic matt grey	44-730.62	22	19	1	0,051
			plastic matt chrome	44-730.22	22	19	1	0,051

switching action : maintained action = MA, momentary action = M
circuit drawings from page 348, technical drawings from page 334, mounting dimensions from page 347

with 2 positions
Arrangement of switching element corresponds to marking of front adaptor

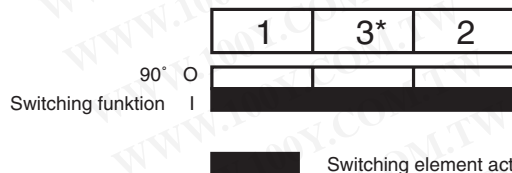

*By using of not stackable, switching elements please cover the outside positions 1 and 2 of frontadapter.

keylock switch actuator 3 positions

up to 3 switching elements max. in 1. level



- front adapter page 327
- slow-make switching element stackable for front mounting page 327
- slow-make switching element not stackable for front mounting page 328
- base adaptor page 328
- slow-make switching element not stackable for base mounting page 328



	switching action	key removable in	front ring	28.2 mm dia. Typ-Nr.	circuit drawing	technical drawing	mounting dimensions	
keylock switch actuator 3 positions	momentary - 0 - momentary	0	plastic matt grey	44-735.61	24	19	1	0,051
			plastic matt chrome	44-735.21	24	19	1	0,051
position 0: basic position position I + II: maintained action 60° standard lock 9500 other lock numbers on request	maintained - 0 - maintained	0	plastic matt grey	44-734.61	27	19	1	0,051
			plastic matt chrome	44-734.21	27	19	1	0,051
		0 + II	plastic matt grey	44-734.64	27	19	1	0,051
			plastic matt chrome	44-734.24	27	19	1	0,051
		I + 0	plastic matt grey	44-734.63	27	19	1	0,051
			plastic matt chrome	44-734.23	27	19	1	0,051
I + 0 + II	plastic matt grey	44-734.65	27	19	1	0,051		
	plastic matt chrome	44-734.25	27	19	1	0,051		
position 0: basic position position I: momentary action 60° position II: maintained action 60° standard lock 9500 other lock numbers on request	momentary - 0 - maintained	0	plastic matt grey	44-737.61	26	19	1	0,051
			plastic matt chrome	44-737.21	26	19	1	0,051
		0 + II	plastic matt grey	44-737.64	26	19	1	0,051
			plastic matt chrome	44-737.24	26	19	1	0,051
position 0: basic position position I: maintained action 60° position II: momentary action 60° standard lock 9500 other lock numbers on request	maintained - 0 - momentary	0	plastic matt grey	44-736.61	25	19	1	0,051
			plastic matt chrome	44-736.21	25	19	1	0,051
		I + 0	plastic matt grey	44-736.63	25	19	1	0,051
			plastic matt chrome	44-736.23	25	19	1	0,051

switching action: maintained action = MA, momentary action = M, 0 = basic position

circuit drawings from page 348, technical drawings from page 334, mounting dimensions from page 347

with 3 positions
Arrangement of switching element corresponds to marking of front adaptor



Switching function 2x60°

Switching element actuated

*By using of not stackable, switching elements please cover the outside positions 1 and 2 of frontadapter.

selector switch actuator 2 positions

up to 3 switching elements max. in 1. level



- front adapter page 327
- slow-make switching element stackable for front mounting page 327
- slow-make switching element not stackable for front mounting page 328
- base adaptor page 328
- slow-make switching element not stackable for base mounting page 328

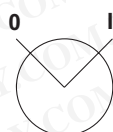

	switching action	lever	front ring	28.2 mm dia. Typ-Nr.	circuit drawing	technical drawing	mounting dimensions	
selector switch actuator 2 positions	M	grey	plastic matt grey	44-722.68	29	20	1	0,021
		black	plastic matt chrome	44-722.20	29	20	1	0,021
position 0: basic position position I: maintained action 90°	MA	grey	plastic matt grey	44-720.68	28	20	1	0,021
		red	plastic matt grey	44-720.62	28	20	1	0,021
		plastic matt chrome	44-720.22		28	20	1	0,021
		black	plastic matt chrome	44-720.20	28	20	1	0,021

switching action : maintained action = MA, momentary action = M
 circuit drawings from page 348, technical drawings from page 334, mounting dimensions from page 347

with 2 positions
 Arrangement of switching element
 corresponds to marking of front adaptor

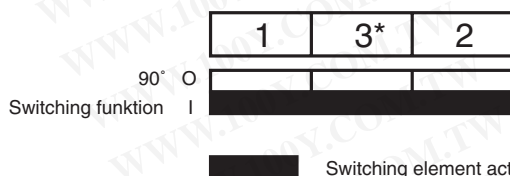

*By using of not stockable, switching elements please cover the outside positions 1 and 2 of frontadapter..

selector switch actuator 3 positions

up to 3 switching elements max. in 1. level



- 🛒 front adapter page 327
- 🛒 slow-make switching element stackable for front mounting page 327
- 🛒 slow-make switching element not stackable for front mounting page 328
- 🛒 base adaptor page 328
- 🛒 slow-make switching element not stackable for base mounting page 328



	switching action	lever	front ring	28.2 mm dia. Typ-Nr.	circuit drawing				technical drawing				mounting dimensions			
selector switch actuator 3 positions	momentary - 0 - momentary	grey	plastic matt grey	44-725.68	31	20	1	0,021								
		black	plastic matt chrome	44-725.20	31	20	1	0,021								
position 0: basic position position I + II: maintained action 60°	maintained - 0 - maintained	grey	plastic matt grey	44-724.68	30	20	1	0,021								
		black	plastic matt chrome	44-724.20	30	20	1	0,021								
position 0: basic position position I: momentary action 60° position II: maintained action 60°	momentary - 0 - maintained	grey	plastic matt grey	44-727.68	33	20	1	0,021								
		black	plastic matt chrome	44-727.20	33	20	1	0,021								
position 0: basic position position I: maintained action 60° position II: momentary action 60°	maintained - 0 - momentary	grey	plastic matt grey	44-726.68	32	20	1	0,021								
		black	plastic matt chrome	44-726.20	32	20	1	0,021								

switching action: maintained action = MA, momentary action = M, 0 = basic position
 circuit drawings from page 348, technical drawings from page 334, mounting dimensions from page 347

with 3 positions
 Arrangement of switching element
 corresponds to marking of front adaptor

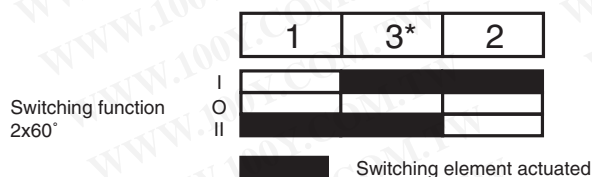

*By using of not stockable, switching elements please cover the outside positions 1 and 2 of frontadapter.

interlocking pushbutton actuator

up to 3 switching elements max. in 1. level



- 🛒 front adapter page 327
- 🛒 slow-make switching element stackable for front mounting page 327
- 🛒 slow-make switching element not stackable for front mounting page 328
- 🛒 base adaptor page 328
- 🛒 slow-make switching element not stackable for base mounting page 328

	front ring	colour of rotation knob	28.2 mm dia. Typ-Nr.	circuit drawing	technical drawing	mounting dimensions	
interlocking pushbutton actuator	plastic matt grey	grey	44-742.68	34	21	1	0,020
		red	44-742.62	34	21	1	0,020
	plastic matt chrome	red	44-742.22	34	21	1	0,020
		black	44-742.20	34	21	1	0,020

circuit drawings from page 348, technical drawings from page 334, mounting dimensions from page 347

potentiometer-drive



	construction	front ring	28.2 mm dia. Typ-Nr.	circuit drawing	technical drawing	mounting dimensions	
potentiometer-drive	without potentiometer	plastic matt grey	44-744.60		22	1	0,016
		plastic matt chrome	44-744.20		22	1	0,016
standard 10 kOhm others on request, resistance value as per IEC 63, series E3	with potentiometer 10 kΩ	plastic matt grey	44-745.60-10K1	35	22	1	0,030
		plastic matt chrome	44-745.20-10K1	35	22	1	0,030

circuit drawings from page 348, technical drawings from page 334, mounting dimensions from page 347

enclosure fitted with pushbuttons

for each mounting place 2 switching elements, 1 normally closed + 1 normally open



	fitting	switching action	symbol on the lens	colour of housing	72 x 84 mm Typ-Nr.	72 x 117 mm Typ-Nr.	technical drawing
enclosure fitted with pushbuttons	1 pushbutton green	M	mom	light grey	44-001.8-01		23 0,205
	1 pushbutton red	M	0	light grey	44-001.8-02		23 0,206
	2 pushbuttons green + red	M	green: I; red: 0	light grey		44-002.8-04	23 0,247

switching action : momentary action = M
technical drawings from page 334

enclosure fitted with emergency stop switch

for each mounting place 2 switching elements, 1 normally closed + 1 normally open

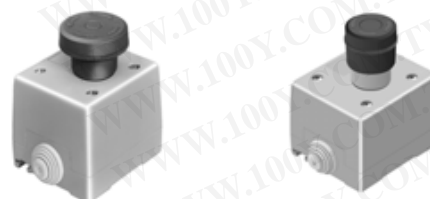

	fitting	unlocking	switching action	colour of housing	72 x 84 mm Typ-Nr.	technical drawing
enclosure fitted with emergency stop switch front protection IP 65	1 emergency stop switch foolproof 37 mm dia.	twist to release	MA	yellow	44-001.4-05	23 0,234
	1 emergency stop switch 50 mm dia.	twist to release	MA	yellow	44-001.4-03	23 0,234

switching action : maintained action = MA
technical drawings from page 334

indicator actuator full face illumination for flush mounting not for marking



- ☞ filament lamp page 329
- ☞ LED page 329
- ☞ front bezel set for flush mounting without label support page 322
- ☞ front bezel set for flush mounting with label support page 323
- ☞ label for front bezel set for flush mounting with label support page 323
- ☞ front adapter page 327
- ☞ lamp element for front mounting page 328
- ☞ base adaptor page 328
- ☞ lamp for base mounting page 329

	front ring	colour of lens	28.2 mm dia. Typ-Nr.	technical drawing		mounting dimensions
indicator actuator full face illumination for flush mounting not for marking	plastic matt grey	blue	44-750.66	24	4	0,008
		colourless, clear	44-750.67	24	4	0,008
		yellow	44-750.64	24	4	0,008
		green	44-750.65	24	4	0,008
		red	44-750.62	24	4	0,008
	plastic matt chrome	blue	44-750.26	24	4	0,008
		colourless, clear	44-750.27	24	4	0,008
		yellow	44-750.24	24	4	0,008
		green	44-750.25	24	4	0,008
		red	44-750.22	24	4	0,008

technical drawings from page 334, mounting dimensions from page 347

indicator actuator, front illumination for flush mounting for marking

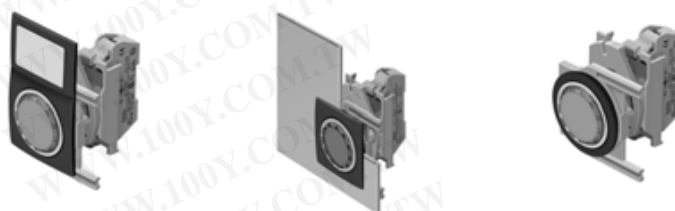

- 🛒 filament lamp page 329
- 🛒 LED page 329
- 🛒 front bezel set for flush mounting without label support page 322
- 🛒 front bezel set for flush mounting with label support page 323
- 🛒 front adapter page 327
- 🛒 lamp element for front mounting page 328
- 🛒 base adaptor page 328
- 🛒 lamp for base mounting page 329

indicator actuator, front illumination for flush mounting for marking	front ring	colour of lens	28.2 mm dia. Typ-Nr.	technical drawing		
				mounting dimensions		
indicator actuator, front illumination for flush mounting for marking	plastic matt grey	blue	44-751.66	24	4	0,007
		yellow	44-751.64	24	4	0,007
		green	44-751.65	24	4	0,007
		red	44-751.62	24	4	0,007
		white	44-751.69	24	4	0,007
	plastic matt chrome	blue	44-751.26	24	4	0,007
		yellow	44-751.24	24	4	0,007
		green	44-751.25	24	4	0,007
		red	44-751.22	24	4	0,007
		white	44-751.29	24	4	0,007

technical drawings from page 334, mounting dimensions from page 347

pushbutton actuator for flush mounting not for marking



- ☞ front bezel set for flush mounting without label support page 322
- ☞ front bezel set for flush mounting with label support page 323
- ☞ label for front bezel set for flush mounting with label support page 323
- ☞ front adapter page 327
- ☞ slow-make switching element stackable for front mounting page 327
- ☞ slow-make switching element not stackable for front mounting page 328
- ☞ base adaptor page 328
- ☞ slow-make switching element not stackable for base mounting page 328

	construction	switching action	front ring	colour of lens	28.2 mm dia. Typ-Nr.	circuit drawing	technical drawing	mounting dimensions			
pushbutton actuator for flush mounting not for marking	front ring flush	M	plastic matt grey	blue	44-701.66	17	25	4	0,013		
				yellow	44-701.64	17	25	4	0,013		
				green	44-701.65	17	25	4	0,013		
				red	44-701.62	17	25	4	0,013		
				black	44-701.60	17	25	4	0,013		
				white	44-701.69	17	25	4	0,013		
				plastic matt chrome	blue	44-701.26	17	25	4	0,013	
			yellow	44-701.24	17	25	4	0,013			
			green	44-701.25	17	25	4	0,013			
			red	44-701.22	17	25	4	0,013			
			black	44-701.20	17	25	4	0,013			
			white	44-701.29	17	25	4	0,013			
			front ring raised	M	plastic matt grey	blue	44-703.66	17	25	4	0,015
						yellow	44-703.64	17	25	4	0,015
	green	44-703.65				17	25	4	0,015		
	red	44-703.62				17	25	4	0,015		
	black	44-703.60				17	25	4	0,015		
	white	44-703.69				17	25	4	0,015		
	plastic matt chrome			blue	44-703.26	17	25	4	0,015		
				yellow	44-703.24	17	25	4	0,015		
green				44-703.25	17	25	4	0,015			
red				44-703.22	17	25	4	0,015			
			black	44-703.20	17	25	4	0,015			
			white	44-703.29	17	25	4	0,015			

Continued on next page

	construction	switching action	front ring	colour of lens	28.2 mm dia. Typ-Nr.	circuit drawing	technical drawing	mounting dimensions					
pushbutton actuator for flush mounting not for marking	with knob high	M	plastic matt grey	blue	44-704.66	17	25	4	0,015				
				yellow	44-704.64	17	25	4	0,015				
				green	44-704.65	17	25	4	0,015				
				red	44-704.62	17	25	4	0,015				
				black	44-704.60	17	25	4	0,015				
				white	44-704.69	17	25	4	0,015				
			plastic matt chrome	blue	44-704.26	17	25	4	0,015				
				yellow	44-704.24	17	25	4	0,015				
				green	44-704.25	17	25	4	0,015				
				red	44-704.22	17	25	4	0,015				
				black	44-704.20	17	25	4	0,015				
				white	44-704.29	17	25	4	0,015				
				up to 3 switching elements max.	front ring flush	MA	plastic matt grey	blue	44-702.66	18	25	4	0,013
								yellow	44-702.64	18	25	4	0,013
green	44-702.65	18	25					4	0,013				
red	44-702.62	18	25					4	0,013				
black	44-702.60	18	25					4	0,013				
white	44-702.69	18	25					4	0,013				
plastic matt chrome	blue	44-702.26	18				25	4	0,013				
	yellow	44-702.24	18				25	4	0,013				
	green	44-702.25	18				25	4	0,013				
	red	44-702.22	18				25	4	0,013				
	black	44-702.20	18				25	4	0,013				
	white	44-702.29	18				25	4	0,013				
up to 3 switching elements max.	front ring raised	MA	plastic matt grey	blue	44-705.66	18	25	4	0,015				
				yellow	44-705.64	18	25	4	0,015				
				green	44-705.65	18	25	4	0,015				
				red	44-705.62	18	25	4	0,015				
				black	44-705.60	18	25	4	0,015				
				white	44-705.69	18	25	4	0,015				
			plastic matt chrome	blue	44-705.26	18	25	4	0,015				
				yellow	44-705.24	18	25	4	0,015				
				green	44-705.25	18	25	4	0,015				
				red	44-705.22	18	25	4	0,015				
				black	44-705.20	18	25	4	0,015				
				white	44-705.29	18	25	4	0,015				
up to 3 switching elements max.	with knob high	MA	plastic matt grey	blue	44-706.66	18	25	4	0,015				
				yellow	44-706.64	18	25	4	0,015				
				green	44-706.65	18	25	4	0,015				
				red	44-706.62	18	25	4	0,015				
				black	44-706.60	18	25	4	0,015				
				white	44-706.69	18	25	4	0,015				
			plastic matt chrome	blue	44-706.26	18	25	4	0,015				
				yellow	44-706.24	18	25	4	0,015				
				green	44-706.25	18	25	4	0,015				
				red	44-706.22	18	25	4	0,015				
				black	44-706.20	18	25	4	0,015				
				white	44-706.29	18	25	4	0,015				

switching action : momentary action = M, maintained action = MA

circuit drawings from page 348, technical drawings from page 334, mounting dimensions from page 347

pushbutton actuator for flush mounting for marking

colour of lens is determined by the colour of text plate

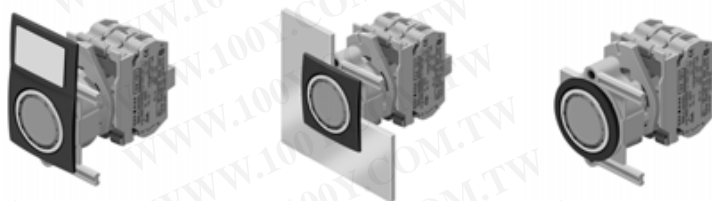

- 🛒 marking plate page 322
- 🛒 front bezel set for flush mounting without label support page 322
- 🛒 front bezel set for flush mounting with label support page 323
- 🛒 label for front bezel set for flush mounting with label support page 323
- 🛒 front adapter page 327
- 🛒 slow-make switching element stackable for front mounting page 327
- 🛒 slow-make switching element not stackable for front mounting page 328
- 🛒 base adaptor page 328
- 🛒 slow-make switching element not stackable for base mounting page 328

	switching action	front ring	colour of lens	28.2 mm dia. Typ-Nr.	circuit drawing	technical drawing	mounting dimensions	
pushbutton actuator for flush mounting for marking	M	plastic matt grey	clear	44-701.67	17	26	4	0,012
		plastic matt chrome	clear	44-701.27	17	26	4	0,012
up to 3 switching elements max.	MA	plastic matt grey	clear	44-702.67	18	26	4	0,012
		plastic matt chrome	clear	44-702.27	18	26	4	0,012

switching action : momentary action = M, maintained action = MA

circuit drawings from page 348, technical drawings from page 334, mounting dimensions from page 347

illuminated pushbutton actuator for flush mounting for marking



- 🛒 filament lamp page 329
- 🛒 LED page 329
- 🛒 front bezel set for flush mounting without label support page 322
- 🛒 front bezel set for flush mounting with label support page 323
- 🛒 label for front bezel set for flush mounting with label support page 323
- 🛒 front adapter page 327
- 🛒 slow-make switching element stackable for front mounting page 327
- 🛒 slow-make switching element not stackable for front mounting page 328
- 🛒 lamp element for front mounting page 328
- 🛒 base adaptor page 328
- 🛒 slow-make switching element not stackable for base mounting page 328
- 🛒 lamp for base mounting page 329

	switching action	front ring	colour of lens	28.2 mm dia. Typ-Nr.	circuit drawing	technical drawing	mounting dimensions	
illuminated pushbutton actuator for flush mounting for marking	M	plastic matt grey	blue	44-746.66	19	26	4	0,012
			yellow	44-746.64	19	26	4	0,012
			green	44-746.65	19	26	4	0,012
			red	44-746.62	19	26	4	0,012
			white	44-746.69	19	26	4	0,012
		plastic matt chrome	blue	44-746.26	19	26	4	0,012
			yellow	44-746.24	19	26	4	0,012
			green	44-746.25	19	26	4	0,012
			red	44-746.22	19	26	4	0,012
			white	44-746.29	19	26	4	0,012
with text plate translucent white, up to max. 3 switching elements	MA	plastic matt grey	blue	44-747.66	20	26	4	0,012
			yellow	44-747.64	20	26	4	0,012
			green	44-747.65	20	26	4	0,012
			red	44-747.62	20	26	4	0,012
			white	44-747.69	20	26	4	0,012
		plastic matt chrome	blue	44-747.26	20	26	4	0,012
			yellow	44-747.24	20	26	4	0,012
			green	44-747.25	20	26	4	0,012
			red	44-747.22	20	26	4	0,012
			white	44-747.29	20	26	4	0,012

switching action : momentary action = M, maintained action = MA

circuit drawings from page 348, technical drawings from page 334, mounting dimensions from page 347

keylock switch actuator 2 positions for flush mounting

up to 3 switching elements max. in 1. level

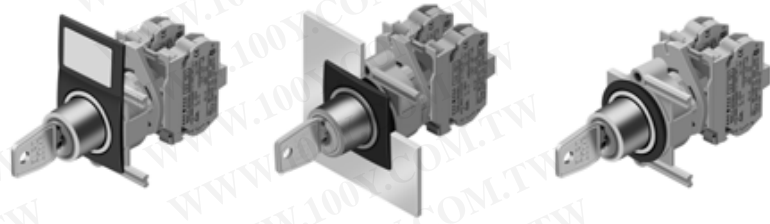

- ☞ front bezel set for flush mounting without label support page 322
- ☞ front bezel set for flush mounting with label support page 323
- ☞ label for front bezel set for flush mounting with label support page 323
- ☞ front adaptor page 327
- ☞ slow-make switching element stackable for front mounting page 327
- ☞ slow-make switching element not stackable for front mounting page 328
- ☞ base adaptor page 328
- ☞ slow-make switching element not stackable for base mounting page 328

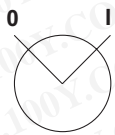

	switching action	key removable in	front ring	28.2 mm dia. Typ-Nr.	circuit drawing	technical drawing	mounting dimensions	
keylock switch actuator 2 positions for flush mounting	M	0	plastic matt grey	44-732.61	23	27	4	0,051
			plastic matt chrome	44-732.21	23	27	4	0,051
position 0: basic position position I: maintained action 90° standard lock 9500 other lock numbers on request	MA	0	plastic matt grey	44-730.61	22	27	4	0,051
			plastic matt chrome	44-730.21	22	27	4	0,051
		0 + I	plastic matt grey	44-730.62	22	27	4	0,051
			plastic matt chrome	44-730.22	22	27	4	0,051

switching action : maintained action = MA, momentary action = M
circuit drawings from page 348, technical drawings from page 334, mounting dimensions from page 347

with 2 positions
Arrangement of switching element corresponds to marking of front adaptor

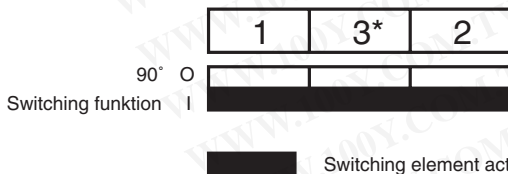

*By using of not stackable, switching elements please cover the outside positions 1 and 2 of frontadaptor.

keylock switch actuator 3 positions for flush mounting

up to 3 switching elements max. in 1. level

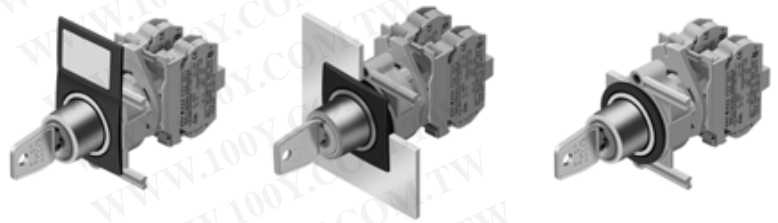

- 🛒 front bezel set for flush mounting without label support page 322
- 🛒 front bezel set for flush mounting with label support page 323
- 🛒 label for front bezel set for flush mounting with label support page 323
- 🛒 front adapter page 327
- 🛒 slow-make switching element stackable for front mounting page 327
- 🛒 slow-make switching element not stackable for front mounting page 328
- 🛒 base adaptor page 328
- 🛒 slow-make switching element not stackable for base mounting page 328



	switching action	key removable in	front ring	28.2 mm dia. Typ-Nr.	circuit drawing	technical drawing	mounting dimensions	
keylock switch actuator 3 positions for flush mounting	momentary - 0 - momentary	0	plastic matt grey	44-735.61	24	27	4	0,051
			plastic matt chrome	44-735.21	24	27	4	0,051
position 0: basic position position I + II: maintained action 60° standard lock 9500 other lock numbers on request	maintained - 0 - maintained	0	plastic matt grey	44-734.61	27	27	4	0,051
			plastic matt chrome	44-734.21	27	27	4	0,051
		0 + II	plastic matt grey	44-734.64	27	27	4	0,051
			plastic matt chrome	44-734.24	27	27	4	0,051
		I + 0	plastic matt grey	44-734.63	27	27	4	0,051
			plastic matt chrome	44-734.23	27	27	4	0,051
position 0: basic position position I: momentary action 60° position II: maintained action 60° standard lock 9500 other lock numbers on request	momentary - 0 - maintained	0	plastic matt grey	44-737.61	26	27	4	0,051
			plastic matt chrome	44-737.21	26	27	4	0,051
		0 + II	plastic matt grey	44-737.64	26	27	4	0,051
			plastic matt chrome	44-737.24	26	27	4	0,051
position 0: basic position position I: maintained action 60° position II: momentary action 60° standard lock 9500 other lock numbers on request	maintained - 0 - momentary	0	plastic matt grey	44-736.61	25	27	4	0,051
			plastic matt chrome	44-736.21	25	27	4	0,051
		I + 0	plastic matt grey	44-736.63	25	27	4	0,051
			plastic matt chrome	44-736.23	25	27	4	0,051

switching action: maintained action = MA, momentary action = M, 0 = basic position

circuit drawings from page 348, technical drawings from page 334, mounting dimensions from page 347

with 3 positions
Arrangement of switching element corresponds to marking of front adaptor

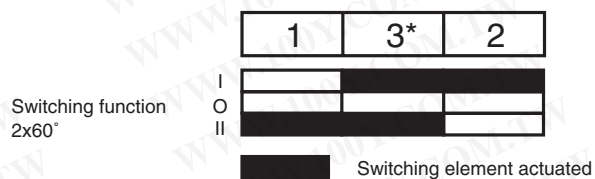

*By using of not stockable, switching elements please cover the outside positions 1 and 2 of frontadaptor.

selector switch actuator 2 positions for flush mounting

up to 3 switching elements max. in 1. level

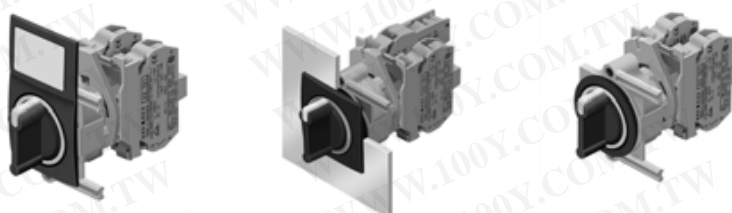

- 🛒 front bezel set for flush mounting without label support page 322
- 🛒 front bezel set for flush mounting with label support page 323
- 🛒 label for front bezel set for flush mounting with label support page 323
- 🛒 front adaptor page 327
- 🛒 slow-make switching element stackable for front mounting page 327
- 🛒 slow-make switching element not stackable for front mounting page 328
- 🛒 base adaptor page 328
- 🛒 slow-make switching element not stackable for base mounting page 328



	switching action	lever	front ring	28.2 mm dia. Typ-Nr.	circuit drawing	technical drawing	mounting dimensions	📐
selector switch actuator 2 positions for flush mounting	M	grey	plastic matt grey	44-722.68	29	28	4	0,021
		black	plastic matt chrome	44-722.20	29	28	4	0,021
position 0: basic position position I: maintained action 90°	MA	grey	plastic matt grey	44-720.68	28	28	4	0,021
		red	plastic matt grey	44-720.62	28	28	4	0,021
			plastic matt chrome	44-720.22	28	28	4	0,021
		black	plastic matt chrome	44-720.20	28	28	4	0,021

switching action : maintained action = MA, momentary action = M
circuit drawings from page 348, technical drawings from page 334, mounting dimensions from page 347

with 2 positions
Arrangement of switching element corresponds to marking of front adaptor

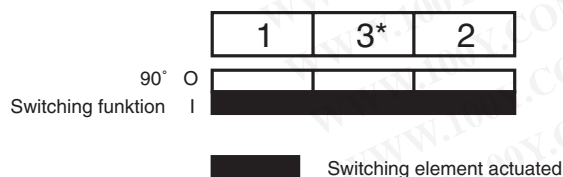

*By using of not stockable, switching elements please cover the outside positions 1 and 2 of frontadaptor.

selector switch actuator 3 positions for flush mounting

up to 3 switching elements max. in 1. level



- 🛒 front bezel set for flush mounting without label support page 322
- 🛒 front bezel set for flush mounting with label support page 323
- 🛒 label for front bezel set for flush mounting with label support page 323
- 🛒 front adapter page 327
- 🛒 slow-make switching element stackable for front mounting page 327
- 🛒 slow-make switching element not stackable for front mounting page 328
- 🛒 base adaptor page 328
- 🛒 slow-make switching element not stackable for base mounting page 328



	switching action	lever	front ring	28.2 mm dia. Typ-Nr.	circuit drawing	technical drawing	mounting dimensions	
selector switch actuator 3 positions for flush mounting	momentary - 0 - momentary	grey	matt grey	44-725.68	31	28	4	0,021
		black	matt chrome	44-725.20	31	28	4	0,021
position 0: basic position position I + II: maintained action 60°	maintained - 0 - maintained	grey	matt grey	44-724.68	30	28	4	0,021
		black	matt chrome	44-724.20	30	28	4	0,021
position 0: basic position position I: momentary action 60° position II: maintained action 60°	momentary - 0 - maintained	grey	matt grey	44-727.68	33	28	4	0,021
		black	matt chrome	44-727.20	33	28	4	0,021
position 0: basic position position I: maintained action 60° position II: momentary action 60°	maintained - 0 - momentary	grey	matt grey	44-726.68	32	28	4	0,021
		black	matt chrome	44-726.20	32	28	4	0,021

switching action: : maintained action = MA, momentary action = M, 0 = basic position
 circuit drawings from page 348, technical drawings from page 334, mounting dimensions from page 347

with 3 positions
 Arrangement of switching element corresponds to marking of front adaptor

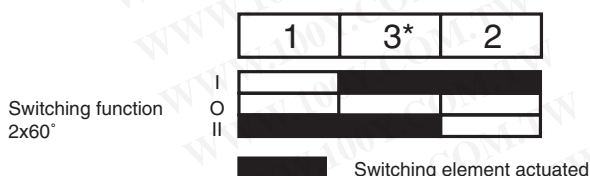

* By using of not stockable, switching elements please cover the outside positions 1 and 2 of frontadaptor.

interlocking pushbutton actuator for flush mounting

up to 3 switching elements max. in 1. level



- 🛒 front bezel set for flush mounting without label support page 322
- 🛒 front bezel set for flush mounting with label support page 323
- 🛒 label for front bezel set for flush mounting with label support page 323
- 🛒 front adapter page 327
- 🛒 slow-make switching element stackable for front mounting page 327
- 🛒 slow-make switching element not stackable for front mounting page 328
- 🛒 base adaptor page 328
- 🛒 slow-make switching element not stackable for base mounting page 328

	front ring	colour of rotation knob	28.2 mm dia. Typ-Nr.	circuit drawing	technical drawing	mounting dimensions	
interlocking pushbutton actuator for flush mounting	plastic matt grey	grey	44-742.68	34	29	4	0,020
		red	44-742.62	34	29	4	0,020
	plastic matt chrome	red	44-742.22	34	29	4	0,020
		black	44-742.20	34	29	4	0,020

circuit drawings from page 348, technical drawings from page 334, mounting dimensions from page 347

potentiometer-drive for flush mounting



- 🛒 front bezel set for flush mounting without label support page 322
- 🛒 front bezel set for flush mounting with label support page 323
- 🛒 label for front bezel set for flush mounting with label support page 323

	construction	front ring	28.2 mm dia. Typ-Nr.	circuit drawing	technical drawing	mounting dimensions	
potentiometer-drive for flush mounting	without potentiometer	plastic matt grey	44-744.60		30	4	0,016
		plastic matt chrome	44-744.20		30	4	0,016
standard 10 kOhm others on request, resistance value as per IEC 63, series E3	with potentiometer 10 kΩ	plastic matt grey	44-745.60-10K1	35	30	4	0,030
		plastic matt chrome	44-745.20-10K1	35	30	4	0,030

circuit drawings from page 348, technical drawings from page 334, mounting dimensions from page 347

at front

lens

for illuminated version

	shape	lens	colour	28.2 mm dia. Typ-Nr.	
lens for indicator front illumination, illuminated pushbutton	flat	transparent	blue	44-966.6	0,001
			colourless, clear	44-966.7	0,001
			yellow	44-966.4	0,001
			green	44-966.5	0,001
			red	44-966.2	0,001





marking plate

	marking plate	colour	part no.	
marking plate for pushbutton for marking	opaque	blue	44-961.6	0,001
		yellow	44-961.4	0,001
		green	44-961.5	0,001
		red	44-961.2	0,001
		black	44-961.0	0,001
for pushbuttons for marking, illuminated pushbuttons, indicators front illumination	translucent	white	44-962.9	0,001



see inscription

front bezel set for flush mounting without label support

	use	material	colour	 36 x 36 mm Typ-Nr.	35.5 mm dia. Typ-Nr.	technical drawing 
front bezel set for flush mounting without label support	for illuminated-/pushbutton, selector- and keylock switch, interlocking pushbutton the mounting depth extends for 12 mm	plastic	black	44-946.03	44-946.03-A	31 0,010
	for indicator, potentiometer the mounting depth extends for 3 mm	plastic	black	44-946.01	44-946.01-A	31 0,006



technical drawings from page 334

front bezel set for flush mounting with label support

	use	material	colour	□ 36 x 60 mm Typ-Nr.	technical drawing	
front bezel set for flush mounting with label support	for illuminated-/pushbutton, selector- and keylock switch, interlocking pushbutton the mounting depth extends for 12 mm	plastic	black	44-946.04	31	0,011
	for indicator, potentiometer the mounting depth extends for 3 mm	plastic	black	44-946.02	31	0,007



technical drawings from page 334

label for front bezel set for flush mounting with label support

	colour	□ 27 x 18 mm Typ-Nr.	
label for front bezel set for flush mounting with label support of plastic, 2 layers (alu/black), autoadhesive	aluminium colourless	44-946	0,001
of plastic, 2 layers (black/white), autoadhesive	black	44-946.0	0,001



see inscription

lens cap

for indicator full face illumination

	lens cap	colour	part no.	
lens cap of plastic incl. sealing ring	transparent	blue	44-965.6	0,003
		colourless, clear	44-965.7	0,003
		yellow	44-965.4	0,003
		green	44-965.5	0,003
		red	44-965.2	0,003



lock cap

	colour	part no.	
lock cap Protection when used under adverse ambient conditions. Remove gasket from the actuator. Cannot be used with the label support.	grey	44-921.08	0,004
	black	44-921.00	0,004



legend plate

	□ 30 x 60 mm Typ-Nr.	technical drawing	
legend plate aluminium anodized, for engraving, for protection IP 40	44-955	32	0,001



technical drawings from page 334

label for enclosure

	colour	19 x 19 mm Typ-Nr.	0,001
label for enclosure of plastic, aluminium plated, unmarked, adhesive	aluminium colourless	44-963	0,001



label for label support

	colour	13 x 26 mm Typ-Nr.	0,001
label for label support	aluminium anodized, black	44-960	0,001



see inscription

label support without label

label to be ordered separatly

	colour	29.5 x 49.5 mm Typ-Nr.	technical drawing	0,002
label support without label of plastic, remove sealing ring from actuator	grey	44-944.08	33	0,002
	black	44-944.00	33	0,002



technical drawings from page 334

label support with label

	colour	29.5 x 49.5 mm Typ-Nr.	technical drawing	0,002
label support with label of plastic, label unmarked, remove sealing ring from actuator	grey	44-945.08	33	0,002
	black	44-945.00	33	0,002



technical drawings from page 334

front ring

for illuminated-/pushbutton actuator

	material	colour	part no.	0,002
front ring	plastic	matt grey	44-967.6	0,002
		matt chrome	44-967.2	0,002



front ring raised

for pushbutton actuator

	material	colour	part no.	0,003
front ring raised	plastic	matt grey	44-968.6	0,003
		matt chrome	44-968.2	0,003



protective cover

only for pushbutton with front ring flush mounted

	part no.	technical drawing	
protective cover hinged, transparent, with means for sealing, front panel thickness up to 3 mm max. Remove anti-twisting nose at the actuator. Fits with types 44-701..., 44-702..., 44-746..., 44-747...	44-922	34	0,007



technical drawings from page 334

protective cap

only for pushbutton with front ring flush mounted

	colour	part no.	
protective cap silicone, protection when used under adverse ambient conditions, remove gasket from the actuator. Cannot be used with the label support.	colourless, transparent	44-917.07	0,002



blind plug

	colour	part no.	technical drawing	
blind plug lamp transformer can be mounted with front adaptor	grey	44-915	35	0,008



technical drawings from page 334

enclosure

incl. base adaptor for base mounting

	mounting spaces	colour	part no.	technical drawing	
enclosure	1 mounting place	light grey	44-001.8	23	0,175
	2 mounting places	light grey	44-002.8	23	0,199
	3 mounting places	light grey	44-003.8	23	0,252
	5 mounting places	light grey	44-005.8	23	0,332



technical drawings from page 334

cable gland PG 16

for enclosure

	part no.	
cable gland M 20 with nut and sealing fixing area 7...13 mm dia.	44-956	0,009



spare key

	part no.	 kg
spare key for standard lock 9500, for other lock numbers complete the part no.	44-919	0,007



assembling

reducing ring

for mounting in 30.5 mm drill

	colour	part no.	 kg
reducing ring	aluminium natural anodized	44-925	0,003



mounting tool

	part no.	 kg
mounting tool for fixing nut, transparent lenses, lens caps and illumination	44-935	0,0



at back

front adaptor

for front mounting

	use	part no.	technical drawing	
front adaptor marked	for switching element with 1 contact element	44-901	36	0,007
	for switching element with 2 contact elements	44-902	36	0,007
	for switching element in 2 levels with 3 contact elements	44-903	36	0,007
not marked	for switching element/lamp element	44-900	36	0,007



technical drawings from page 334

Typ No.	Diagram
44-900	
44-901	
44-902	
44-903	

Frontadaptor beschriftet: Ordnungsziffern für Anschlussbezeichnung nach DIN EN 50013, Funktionsziffern befinden sich auf den Schaltelementen neben den Schraubklemmanschlüssen.

slow-make switching element stackable for front mounting

for front adaptor

	contacts	material of contacts	connection method	part no.	circuit drawing	technical drawing	
slow-make switching element stackable for front mounting forced opening according IEC 947-5-1, DIN VDE 0660 or EN 60947-5-1	1 NO	gold/silver	ST	44-162	36	37	0,014
	1 NC	hard silver	ST	44-161	36	37	0,014
		gold/silver	ST	44-152	38	37	0,014
	1 NC + 1 NO	hard silver	ST	44-151	38	37	0,014
		gold/silver	ST	44-132	37	37	0,017
	hard silver	ST	44-131	37	37	0,017	
not to use with emergency stop switch	1 NC + 1 normally open, overlapping	hard silver	ST	44-141	39	37	0,017



circuit drawings from page 348, technical drawings from page 334

slow-make switching element not stackable for front mounting

for front adaptor

	contacts	material of contacts	connection method	part no.	circuit drawing	technical drawing	
slow-make switching element not stackable for front mounting sealing und spacer	1 NO	hard silver	ST	44-121	36	37	0,010
forced opening according IEC 947-5-1, DIN VDE 0660 or EN 60 947-5-1	1 NC	hard silver	ST	44-111	38	37	0,010



circuit drawings from page 348, technical drawings from page 334

lamp element for front mounting

	connection method	part no.	circuit drawing	technical drawing	
lamp element for front mounting lamp socket Ba9s, max. 2.6 W	ST	44-524	1	38	0,011



circuit drawings from page 348, technical drawings from page 334

base adaptor

	part no.	
base adaptor	44-905	0,006



Typ No. Diagram

44 - 905

1	3	2
---	---	---

slow-make switching element not stackable for base mounting

for base adaptor

	contacts	material of contacts	connection method	part no.	circuit drawing	technical drawing	
slow-make switching element not stackable for base mounting sealing und spacer	1 NO	hard silver	ST	44-221	36	39	0,010
forced opening according IEC 947-5-1, DIN VDE 0660 or EN 60 947-5-1	1 NC	hard silver	ST	44-211	38	39	0,010



circuit drawings from page 348, technical drawings from page 334

lamp for base mounting

	connection method	part no.	circuit drawing	technical drawing	
lamp for base mounting lamp socket Ba9s, max. 2.6 W	ST	44-525	1	40	0,011



circuit drawings from page 348, technical drawings from page 334

blind element

for mounting of lamp transformer

	part no.	technical drawing	
blind element	44-940	41	0,008



technical drawings from page 334

for illumination

Filament lamp

	voltage/current	part no.	
Filament lamp base Ba9s	6 VAC/DC/200 mA 1.2 W	10-1406.1369	0,002
	24 VAC/DC/50 mA 1.2 W	10-1412.1279	0,002
at spiral form 2 x CC - 2 F	110-130 VAC/DC/20 mA 2.4 W	10-1423.1179	0,002
at spiral form CC - 2 F	60 VAC/DC/20 mA 1.2 W	10-1420.1179	0,002



LED

	number of chips	voltage/current	colour	part no.	
LED base Ba9s Note: For optimal illumination we strongly recommend using our new single- chip LEDs. For new designs, only the new single-chip LEDs should be chosen. They can be found on page 669.	8	24 VDC/19 mA	yellow	10-6412.3164	0,003
			green	10-6412.3165	0,003
			red	10-6412.3162	0,003



resistor diode element

	number of diodes	alternating service voltage	mounting method	connection method	part no.	technical drawing	
resistor diode element for incandescent lamp 130 V/2.4 W 1 N 4007	1	Ue = 220-240 VAC	front or base	ST	44-614.11	42	0,009
	2	Ue = 220-240 VAC	front	ST	44-614.21	42	0,015
for incandescent lamp 60 V/1.2 W 1 N 4007	1	Ue = 110-125 VAC	front or base	ST	44-614.12	42	0,009
	2	Ue = 110-125 VAC	front	ST	44-614.22	42	0,015



technical drawings from page 334

diode element

	number of diodes	connection method	part no.	technical drawing	
diode element 1 N 4007, for front or base mounting	1	ST	44-612.1	42	0,009
	2	ST	44-612.2	42	0,011



technical drawings from page 334

lamp transformer

	operation voltage	connection method	part no.	technical drawing	
lamp transformer short-circuit proof, 1.2 VA, 50/60 Hz, for front or base mounting	125/24 V	ST	44-975	43	0,102
	125/6 V	ST	44-970	43	0,102
	230/24 V	ST	44-976	43	0,102
	230/6 V	ST	44-971	43	0,102
	400/24 V	ST	44-977	43	0,102
	400/6 V	ST	44-972	43	0,102



connection method: screw terminal = ST
screw terminal for primary connection, for secondary connection wire tails with core-end sleeves
technical drawings from page 334

capacitor

for lamp voltage reduction

	value	part no.	
capacitor use with 60 V/20 mA, 50 Hz lamp voltage	230 V/0.27 μ F	44-958.090	0,002



Please keep to the country specific security rules.

series resistor

for lamp voltage reduction

	value	part no.	
series resistor for incandescent lamp 110-130 V/2.4 W	230 V/6.8 kΩ	44-957.060	0,002
for incandescent lamp 60 V/1.2 W	110 V/2.7 kΩ	44-957.010	0,002
	125 V/3.3 kΩ	44-957.020	0,002
	145 V/4.7 kΩ	44-957.030	0,002
	230 V/8.2 kΩ	44-957.040	0,002
	240 V/10 kΩ	44-957.050	0,002



Please keep to the country specific security rules.

terminal plate empty

for fitting with series resistors and capacitors

	no. of spaces	part no.	
terminal plate empty	5 spaces 62.5 x 60 x 15 mm	44-959.05	0,025
	10 spaces 125 x 60 x 15 mm	44-959.10	0,045
	15 spaces 187.5 x 60 x 15 mm	44-959.15	0,090
	20 spaces 250 x 60 x 15 mm	44-959.20	0,106



for emergency stop switch

label for emergency stop switch

	marking	Ø 90 mm Typ-Nr.	Ø 60 mm Typ-Nr.	Ø 45 mm Typ-Nr.	
label for emergency stop switch front protection IP 65 when protection foil is removed, yellow, self-adhesiv	ARRET D'URGENCE	44-949.3			0,009
			44-950.3		0,004
Emergency Stop			44-950.2		0,004
		44-949.2		44-951.2	0,002
emergency stop		44-949.1			0,009
			44-950.1	44-951.1	0,002
without		44-949			0,009
			44-950		0,004
				44-951	0,002



enclosure for emergency stop switch

incl. base adaptor for base mounting

	mounting spaces	colour	part no.	technical drawing	
enclosure for emergency stop switch	1 mounting place	yellow	44-001.4	23	0,174



technical drawings from page 334

cable gland PG 16/M 20

for enclosure

	part no.	
cable gland PG16/M 20 with nut and sealing fixing area 7...13 mm dia.	44-956	0,009



slow-make switching element

switching system

switching system

The double-break switching system can be supplied for the following switching functions: 1 normally closed, 1 normally open or 1 changeover contact with or without overlap.

The normally closed contacts have forced opening according to DIN 0660, IEC 947-5-1 and DIN VDE 0113.

The switching element exhibits high reliability due to its H-contact system with relative friction. The normally open and normally closed contacts can be used electrically separated.

The standard version is ideal for high breaking capacities. For lower capacities a special version can be supplied.

material

material of contacts

standard version: Ag-Ni alloy

special version: gold/silver

plastics

UL listed, Cd-free

switching element

PC, PA 6.6 self-extinguishing

mechanical characteristics

actuating force

per switching element ≤ 5 N

(illuminated) pushbutton actuator ≤ 10 N

emergency stop switch actuator ≤ 20 N

emergency stop switch actuator foolproof ≤ 70 N

double pushbutton ≤ 12 N per contact surface

actuating travel

approx. 6 mm

resistance to climate

humidity and heat, constant as per DIN IEC 68 Teil 2-3

humidity and heat, cyclic as per DIN IEC 68 Teil 2-30

storage temperature

-40°C to +70°C

mechanical life

slow-make switching element 10×10^6 switching operations

pushbutton momentary action 5×10^6 switching operations

pushbutton maintained action 1×10^6 cycles of operation

Illuminated pushbutton momentary action 3×10^6 switching operations

illuminated pushbutton maintained action 1×10^6 cycles of operation

interlocking pushbutton 2×10^5 switching operations

emergency button not foolproof 1×10^5 switch rating

emergency button

foolproof 6050 switch rating

keylock switch 2×10^5 cycles of operation

selector switch 2×10^5 cycles of operation

double pushbutton 2×10^5 switching operations per contact surface

resistance to shock

40 g (duration 6 ms) as per IEC 68-2-27

resistance to vibration

sinusoidal, 5 g at 10-500 Hz as per IEC 68-2-6

ambient air temperature

-25°C as per DIN EN 60068-2-1

+60°C as per DIN EN 60068-2-2

degree of protection

actuators at front and enclosure IP 65 for IEC 529/DIN 40050

electrical characteristics

rated insulation voltage

U_i:

slow-make switching element: 660 V

lamp element 250 V

lamp transformer: 660 V

degree of pollution: 3

rated voltage

U_e:

AC-15:

120 V-6A

230 V-6A

400 V-4A

500 V-3A

600 V-1,2A

DC-13:

24 V - 3A

60 V - 1,3A

120 V - 0,6A

250 V - 0,3A

rated impulse withstand voltage

U_{imp}:

lamp element: 2,5 kV

lamp transformer: 6 kV

slow-make switching element: 6 kV

1 NC + 1 NO without overlap:

U_e > 400 V, same polarity

U_{imp} = 4000 V

1 NC + 1 NO with overlap:

U_e > 250 V, same polarity

U_{imp} = 4000 V

rated current

(resistive)I_e:

AC-12: 500 V ~5 A

DC-12:

24 V - 10 A

60 V - 8 A

125 V - 3 A

250 V - 1 A

contact resistance

starting value (initial) ≤ 50 mΩ

electrical life

AC-15: 400 V ~2 A: 1×10^6 switching operations

continuous thermal current I_{th2}

I_{th2} = 10 A

short-circuit protection

max. series fuse to be provided 10 A gL

lamp transformer: short-circuit-proof

rules

approvals

- VDE-Reg.-No. 5310
- UL
- CSA
- German Lloyd
- VDE
- CE (declaration of conformity)

actuator

material

adapter and enclosure

PC

front parts

PA 6, PA 12, PC, chromium-plated ABS

technical drawings

1 indicator complete full face illumination not for marking, indicator complete front illumination for marking
 page 289, 289

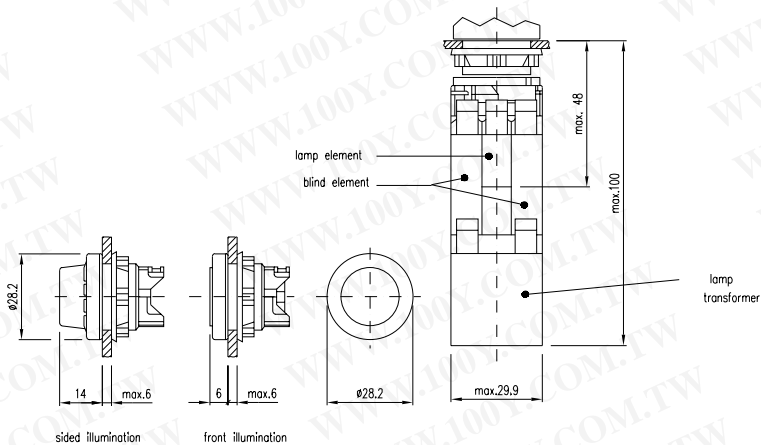

2 pushbutton complete
 page 290

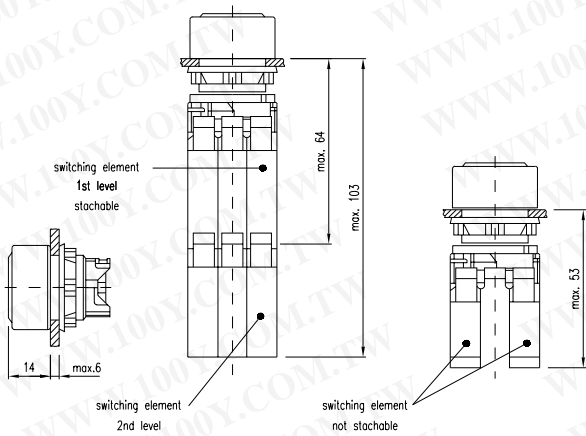

3 illuminated pushbutton complete for marking
 page 290

lamp element

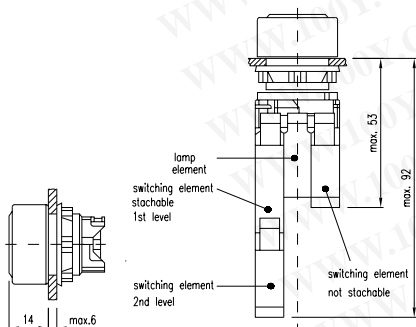

4 emergency stop switch complete

page 291

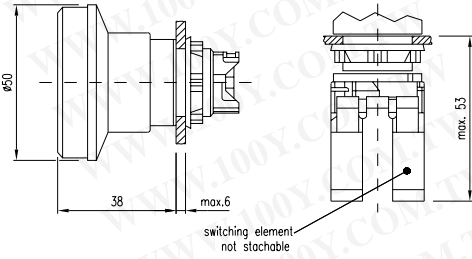

5 emergency stop switch complete

page 291

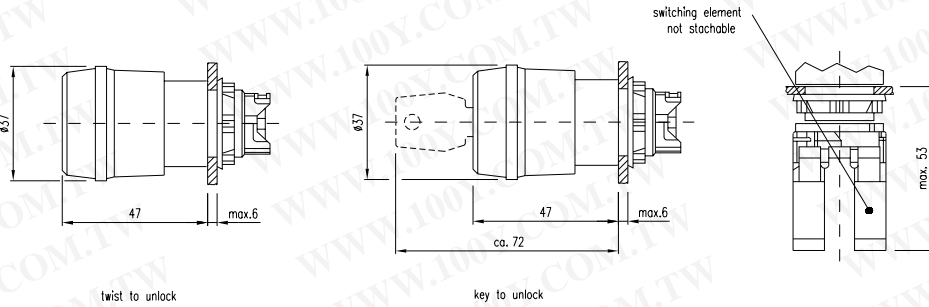

6 key lock complete 2 positions

page 291

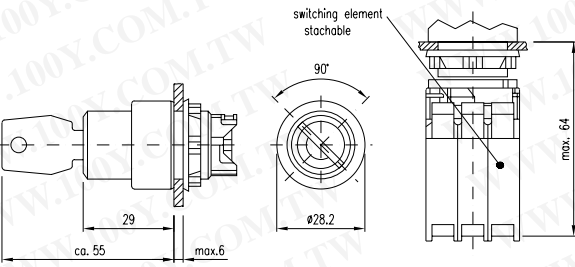

7 key lock complete 3 positions

page 292

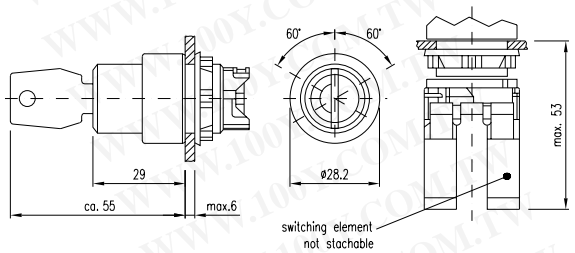

8 selector switch complete 2 positions

page 292

switching element

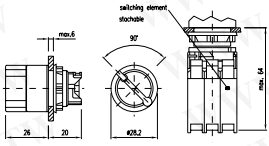

9 selector switch complete 3 positions

page 293

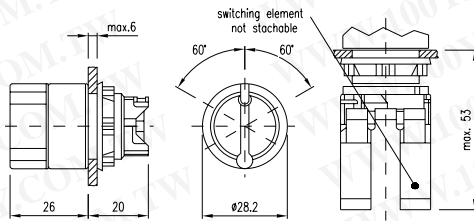

10 indicator actuator, full face illumination not for marking

page 294

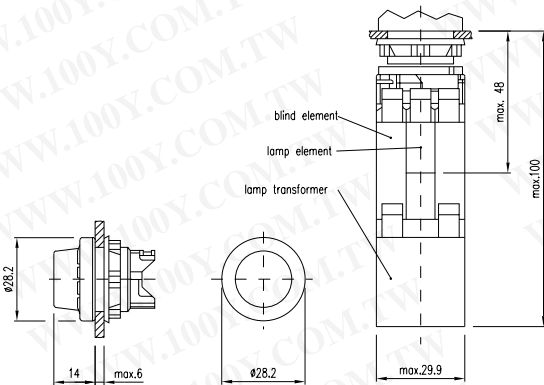

11 indicator actuator, front illumination for flush mounting for marking

page 295

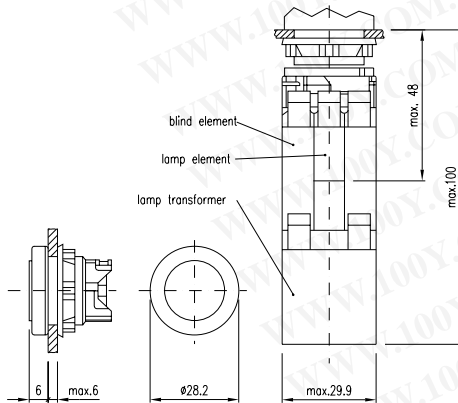

12 pushbutton actuator not for marking page 296

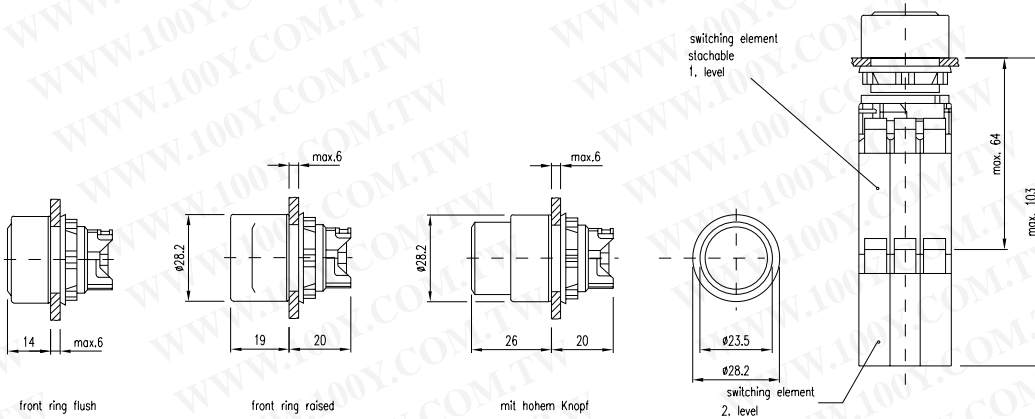

13 pushbutton actuator for marking page 298

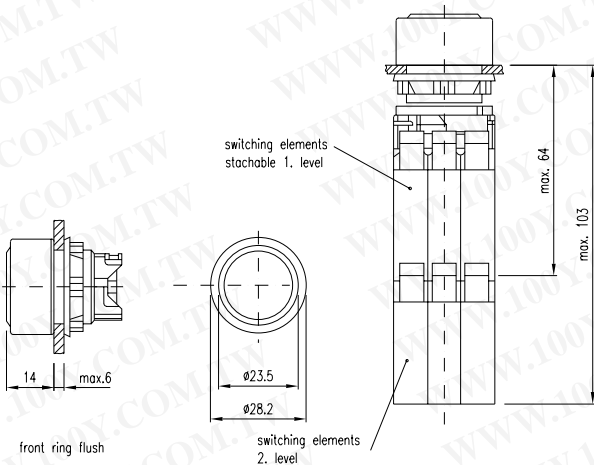

14 illuminated pushbutton actuator for marking page 299

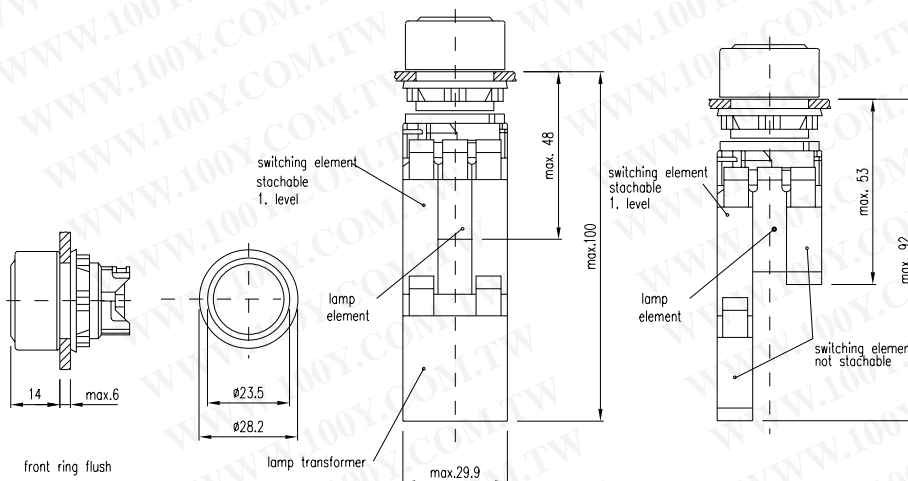

15 double pushbutton actuator

page 300

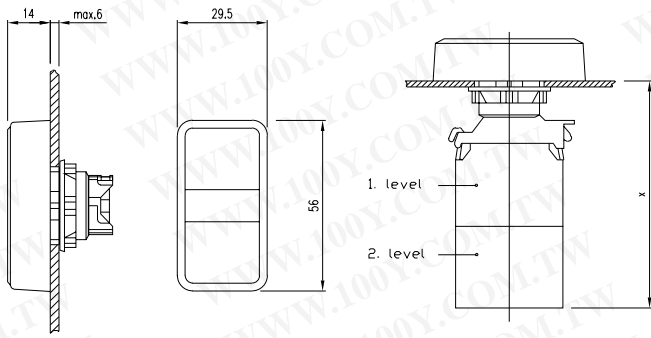

mounting-depth x	1. level	2. level
max. 53mm	44-111/ 44-121	-
max. 64mm	44-111- 44-162	-
max. 92mm	44-131- 44-162	44-111/ 44-121
max. 100mm	44-131- 44-162	44-970- 44-977
max. 103mm	44-131- 44-162	44-131- 44-162

16 emergency stop switch actuator

page 301

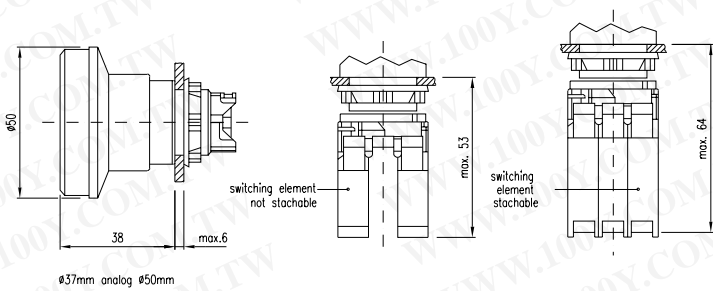

ø37mm analog ø50mm

17 emergency stop switch actuator foolproof

page 302

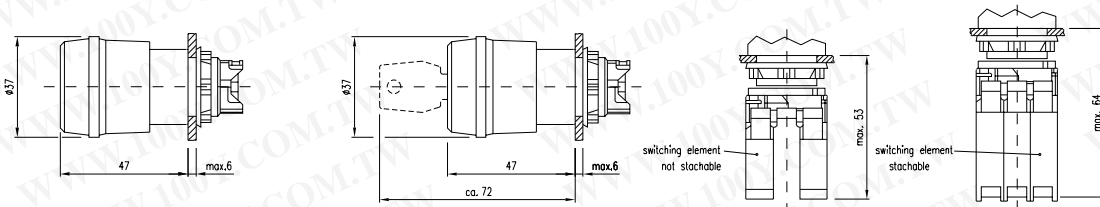

18 pushbutton actuator with mushroom-head cap

page 303

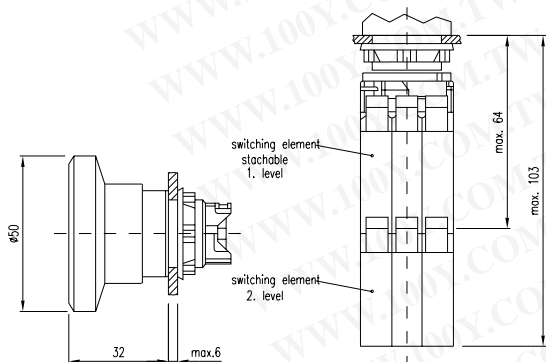

19 keylock switch actuator 2 positions, keylock switch actuator 3 positions
page 304, 305

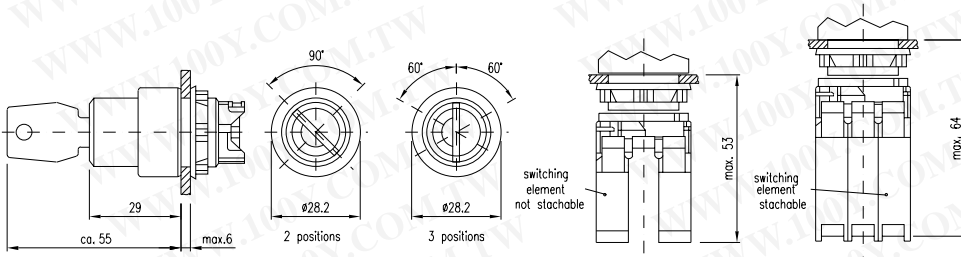

20 selector switch actuator 2 positions, selector switch actuator 3 positions
page 306, 307

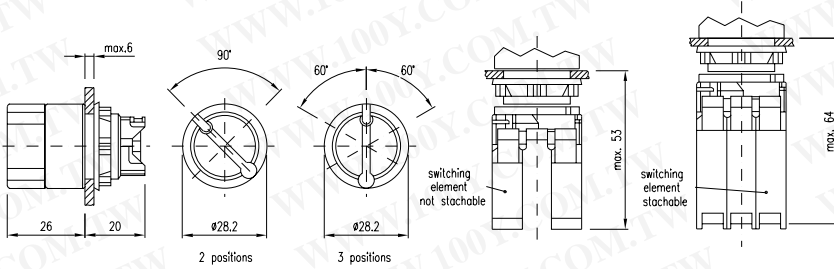

21 interlocking pushbutton actuator
page 308

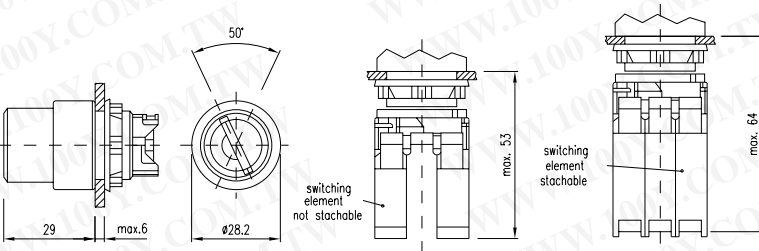

22 potentiometer-drive
page 308

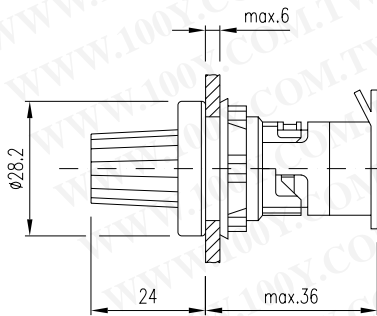

for potentiometer No. 47-745

23 enclosure fitted with pushbuttons, enclosure fitted with emergency stop switch, enclosure, enclosure for emergency stop switch
page 309, 309, 325, 331

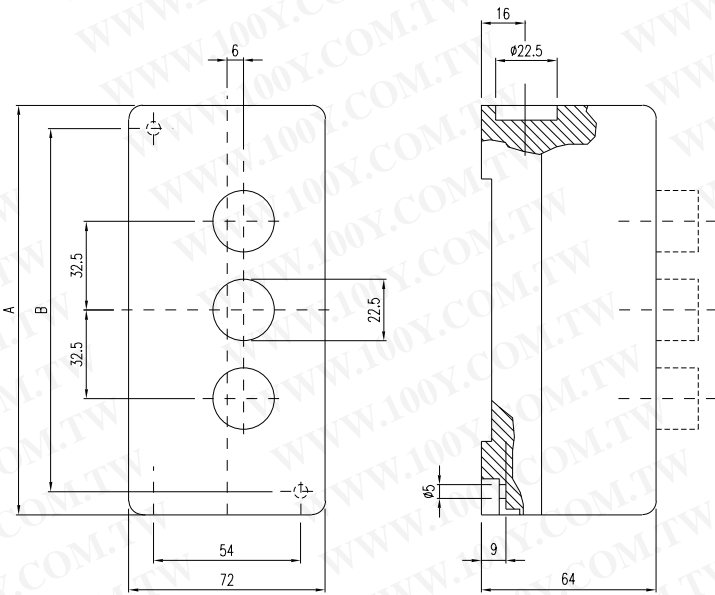

No. buttons	A	B
1	84	67
2	117	100
3	150	133
5	215	198

24 indicator actuator full face illumination for flush mounting not for marking, indicator actuator, front illumination for flush mounting for marking
page 310, 311

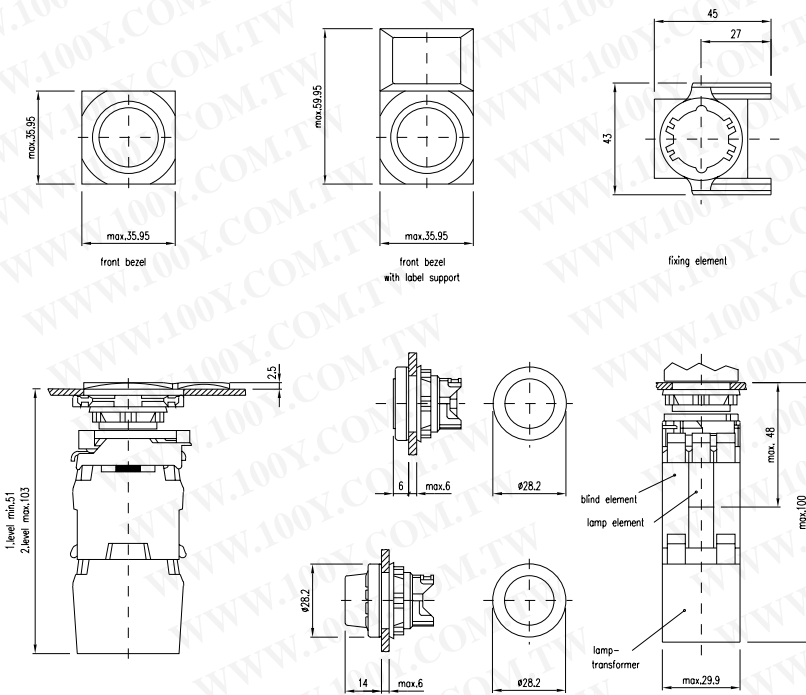

25 pushbutton actuator for flush mounting not for marking page 312

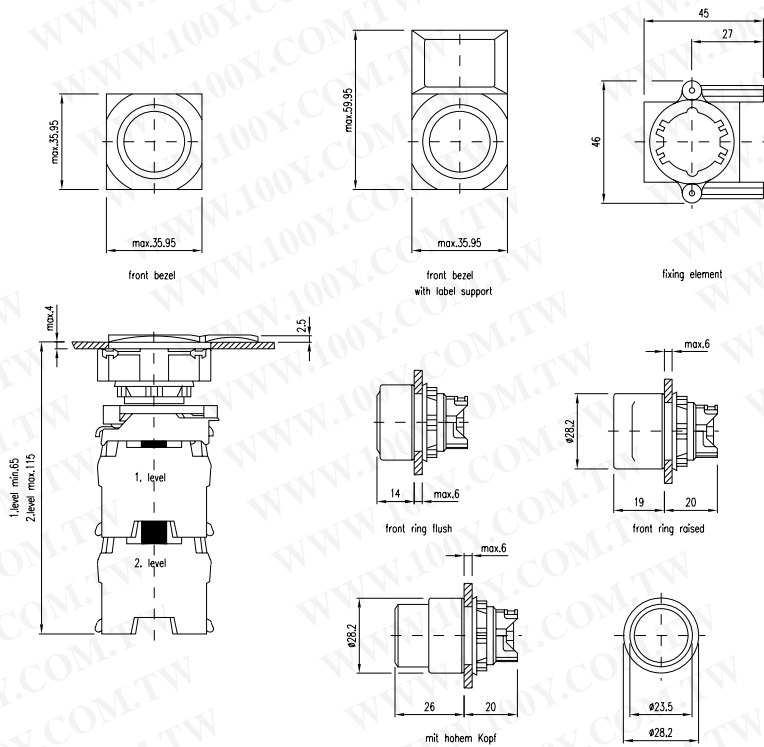

26 pushbutton actuator for flush mounting for marking, illuminated pushbutton actuator for flush mounting for marking page 314, 315

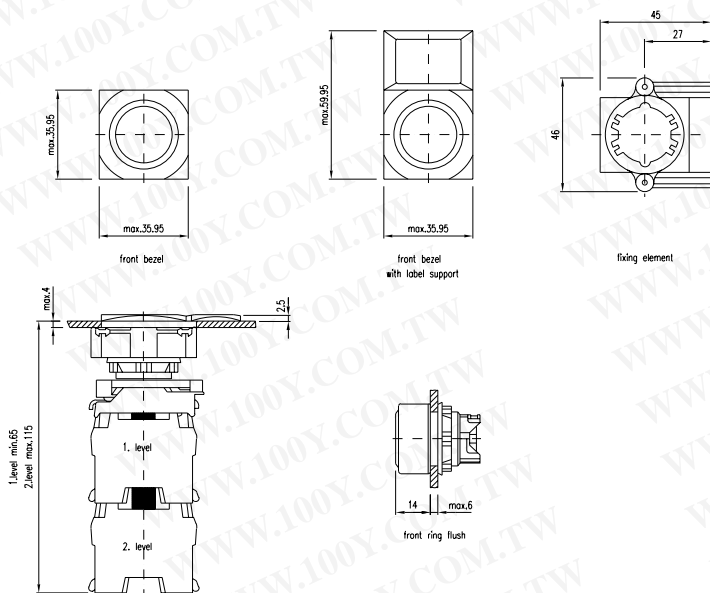

27 keylock switch actuator 2 positions for flush mounting , keylock switch actuator 3 positions for flush mounting
page 316, 317

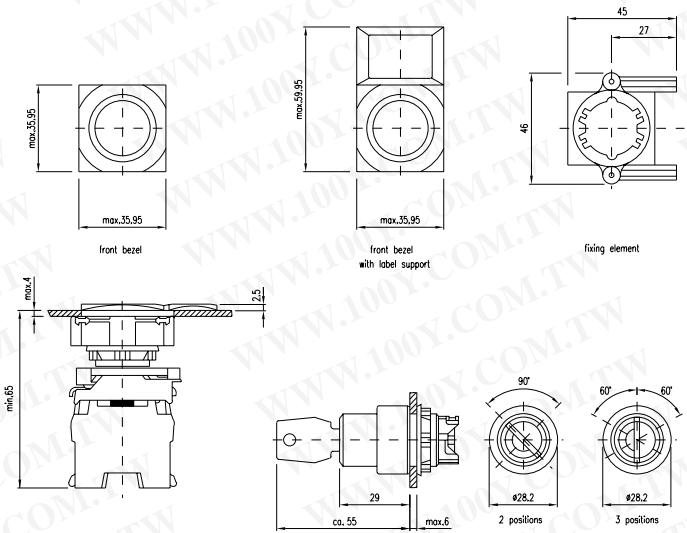

28 selector switch actuator 2 positions for flush mounting , selector switch actuator 3 positions for flush mounting
page 318, 319

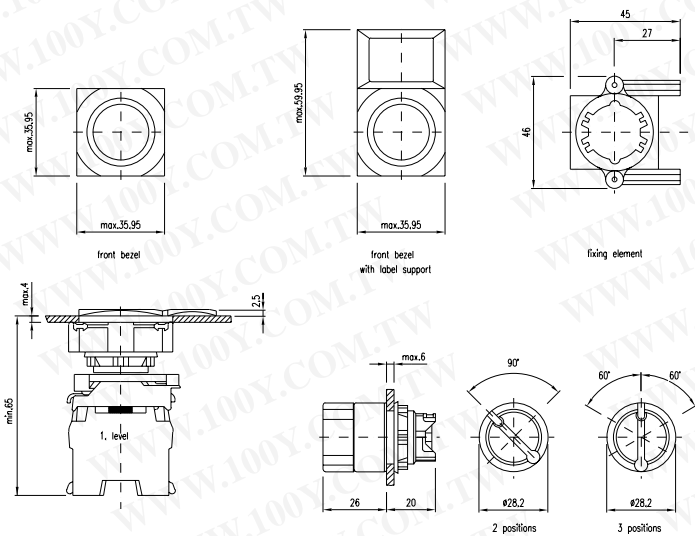

29 interlocking pushbutton actuator for flush mounting
page 320

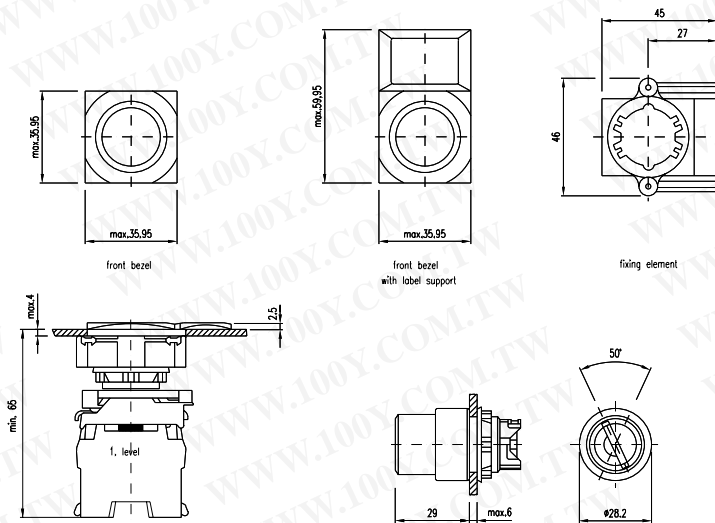

30 potentiometer-drive for flush mounting
page 321

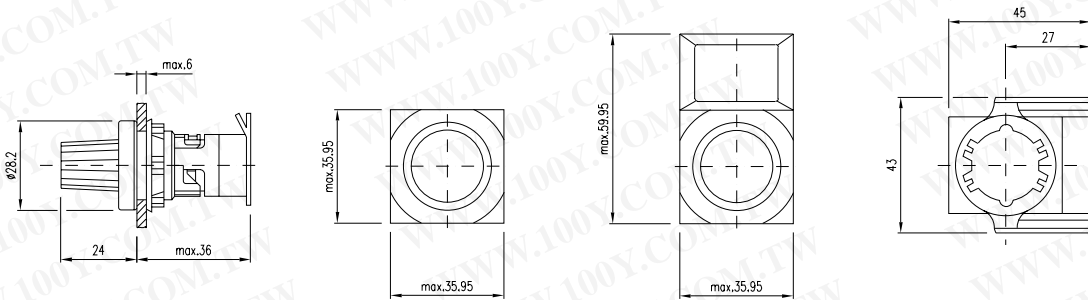

31 front bezel set for flush mounting without label support, front bezel set for flush mounting with label support
page 322, 323

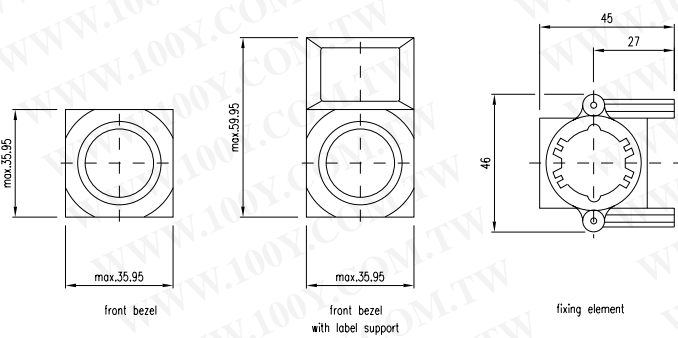

32 legend plate
page 323

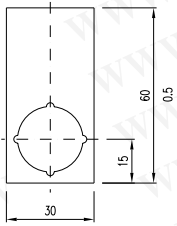

33 label support without label, label support with label
page 324, 324

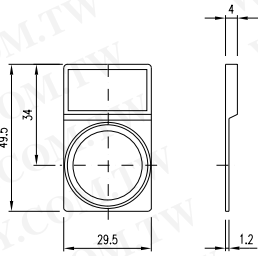

34 protective cover
page 325

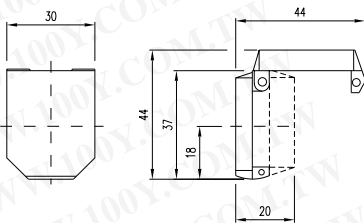

35 blind plug
page 325

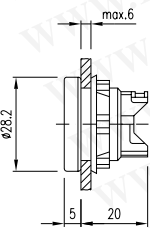

36 front adapter
page 327

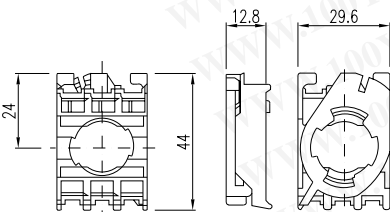

37 slow-make switching element stackable for front mounting, slow-make switching element not stackable for front mounting
page 327, 327

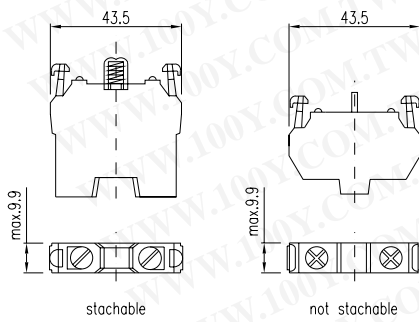

38 lamp element for front mounting
page 328

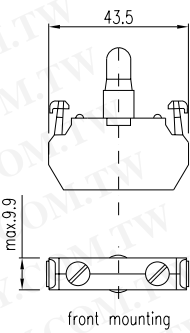

39 slow-make switching element not stackable for base mounting
page 328

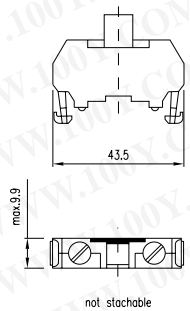

40 lamp for base mounting
page 328

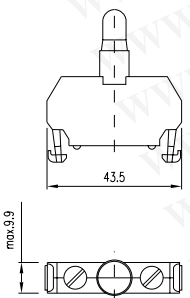

41 blind element
page 329

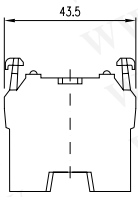

42 resistor diode element, diode element
page 329, 330

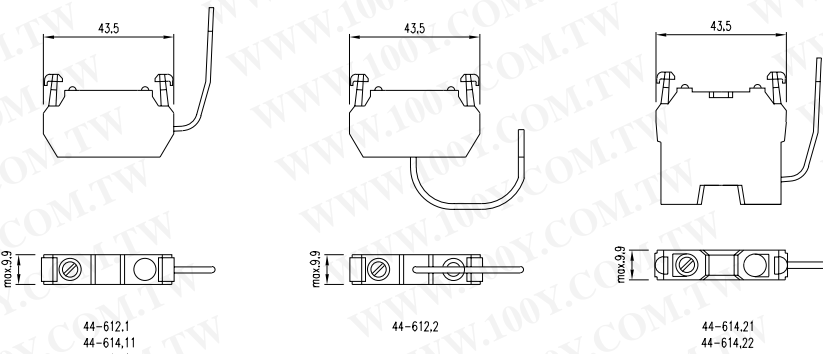

43 lamp transformer
page 330

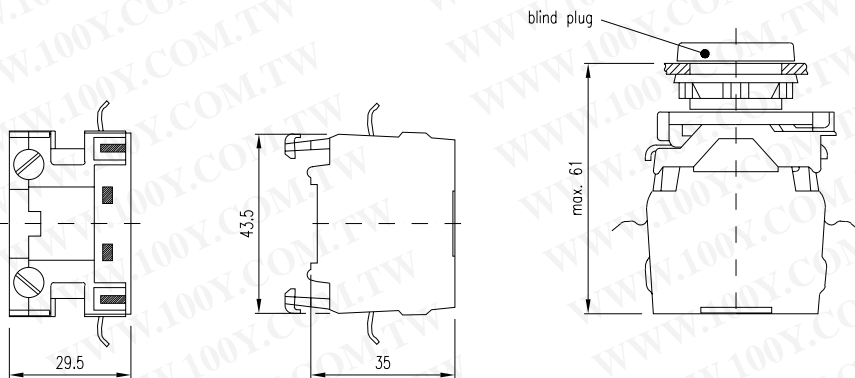

mounting dimensions

1 indicator complete full face illumination not for marking, indicator complete front illumination for marking, pushbutton complete, illuminated pushbutton complete for marking, key lock complete 2 positions, key lock complete 3 positions, selector switch complete 2 positions, selector switch complete 3 positions, indicator actuator, full face illumination not for marking, indicator actuator, front illumination for marking, pushbutton actuator not for marking, pushbutton actuator for marking, illuminated pushbutton actuator for marking, keylock switch actuator 2 positions, keylock switch actuator 3 positions, selector switch actuator 2 positions, selector switch actuator 3 positions, interlocking pushbutton actuator, potentiometer-drive
 page 289, 289, 290, 290, 291, 292, 292, 293, 294, 295, 296, 298, 299, 304, 305, 306, 307, 308, 308

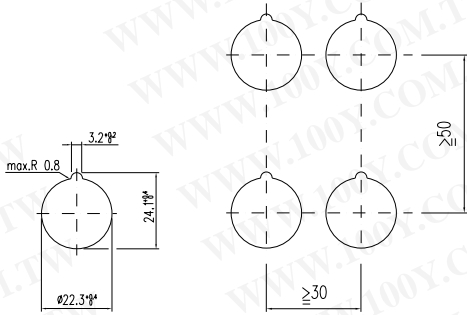

2 emergency stop switch complete, emergency stop switch actuator, emergency stop switch actuator foolproof, pushbutton actuator with mushroom-head cap
 page 291, 301, 302, 303

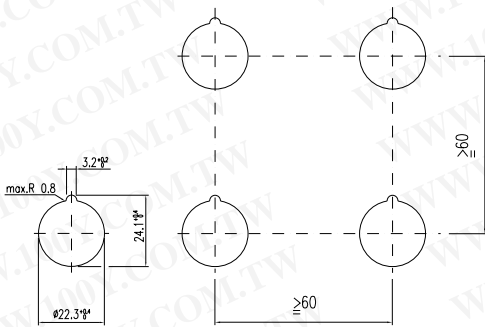

3 double pushbutton actuator
 page 300

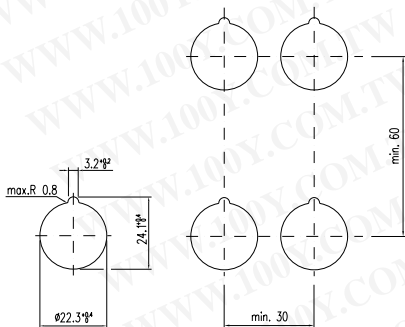

4 indicator actuator full face illumination for flush mounting not for marking, indicator actuator, front illumination for flush mounting for marking, pushbutton actuator for flush mounting not for marking, pushbutton actuator for flush mounting for marking, illuminated pushbutton actuator for flush mounting for marking, keylock switch actuator 2 positions for flush mounting, keylock switch actuator 3 positions for flush mounting, selector switch actuator 2 positions for flush mounting, selector switch actuator 3 positions for flush mounting, interlocking pushbutton actuator for flush mounting, potentiometer-drive for flush mounting
 page 310, 311, 312, 314, 315, 316, 317, 318, 319, 320, 321

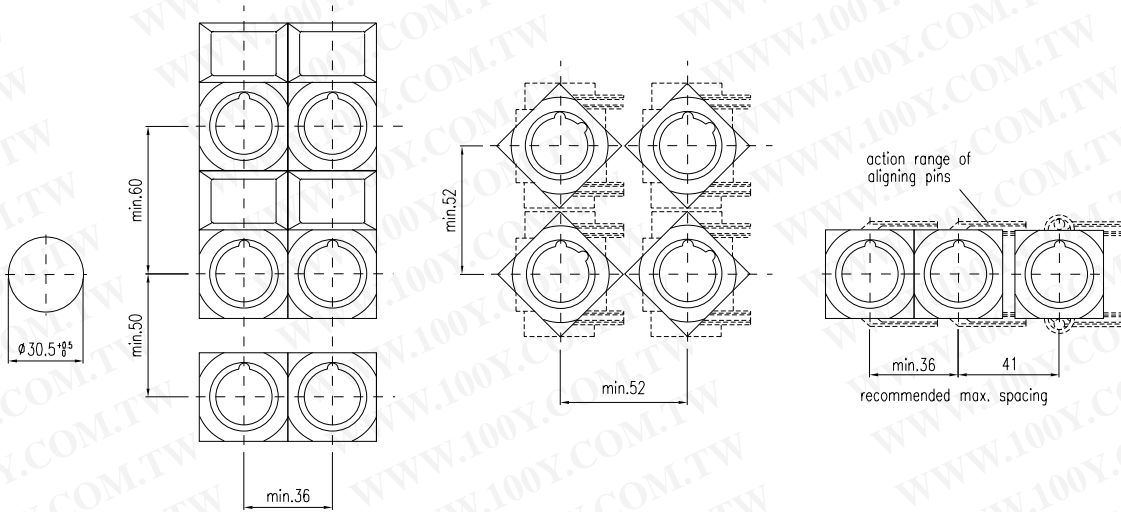

circuit drawings

1 indicator complete full face illumination not for marking, indicator complete front illumination for marking, lamp element for front mounting, lamp for base mounting
 page 289, 289, 328, 328



2 pushbutton complete
 page 290

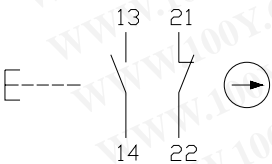

3 pushbutton complete
 page 290

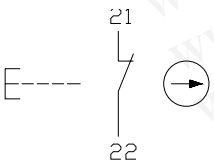

4 pushbutton complete
 page 290

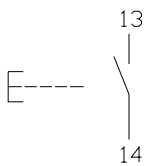

5 pushbutton complete

page 290

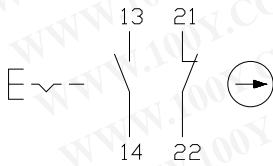

6 pushbutton complete

page 290

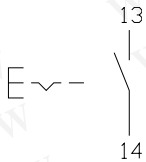

7 illuminated pushbutton complete for marking

page 290

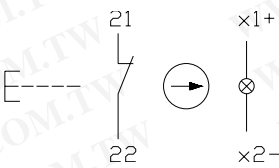

8 illuminated pushbutton complete for marking

page 290

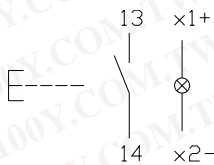

9 illuminated pushbutton complete for marking

page 290

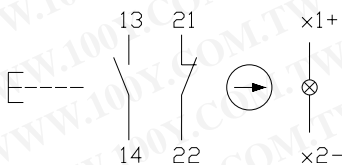

10 illuminated pushbutton complete for marking

page 290

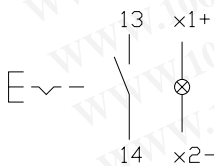

11 illuminated pushbutton complete for marking

page 290

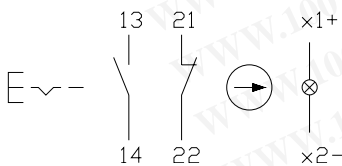

12 emergency stop switch complete

page 291

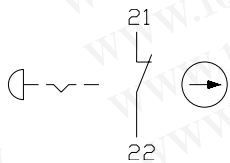

13 key lock complete 2 positions

page 291

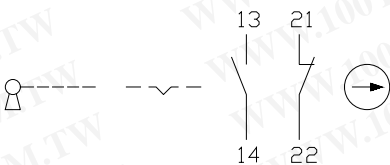

14 key lock complete 3 positions

page 292

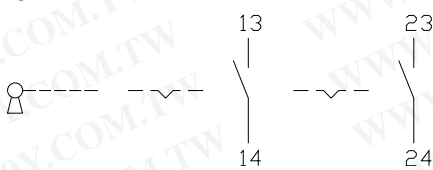

15 selector switch complete 2 positions

page 292

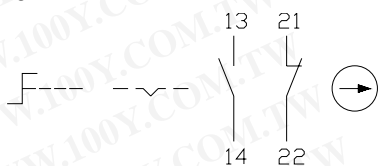

16 selector switch complete 3 positions

page 293

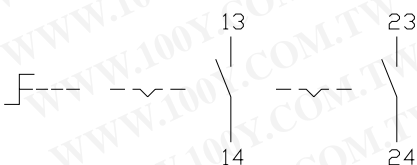

17 pushbutton actuator not for marking, pushbutton actuator for marking, pushbutton actuator with mushroom-head cap, pushbutton actuator for flush mounting not for marking, pushbutton actuator for flush mounting for marking

page 296, 298, 303, 312, 314



18 pushbutton actuator not for marking, pushbutton actuator for marking, pushbutton actuator for flush mounting not for marking, pushbutton actuator for flush mounting for marking

page 296, 298, 312, 314



19 illuminated pushbutton actuator for marking, illuminated pushbutton actuator for flush mounting for marking
page 299, 315

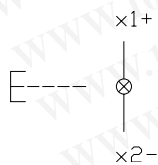

20 illuminated pushbutton actuator for marking, illuminated pushbutton actuator for flush mounting for marking
page 299, 315,

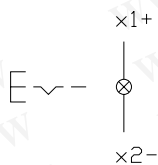

21 emergency stop switch actuator, emergency stop switch actuator foolproof
page 301, 302



22 keylock switch actuator 2 positions, keylock switch actuator 2 positions for flush mounting
page 304, 316



23 keylock switch actuator 2 positions, keylock switch actuator 2 positions for flush mounting
page 304, 316



24 keylock switch actuator 3 positions, keylock switch actuator 3 positions for flush mounting
page 305, 317



25 keylock switch actuator 3 positions, keylock switch actuator 3 positions for flush mounting
page 305, 317

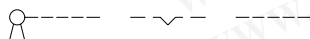

26 keylock switch actuator 3 positions, keylock switch actuator 3 positions for flush mounting

page 305, 317,

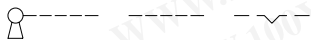

27 keylock switch actuator 3 positions, keylock switch actuator 3 positions for flush mounting

page 305, 317



28 selector switch actuator 2 positions, selector switch actuator 2 positions for flush mounting

page 306, 318



29 selector switch actuator 2 positions, selector switch actuator 2 positions for flush mounting

page 306, 318,



30 selector switch actuator 3 positions, selector switch actuator 3 positions for flush mounting

page 307, 319



31 selector switch actuator 3 positions, selector switch actuator 3 positions for flush mounting

page 307, 319

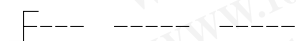

32 selector switch actuator 3 positions, selector switch actuator 3 positions for flush mounting

page 307, 319



33 selector switch actuator 3 positions , selector switch actuator 3 positions for flush mounting
page 307, 319



34 interlocking pushbutton actuator, interlocking pushbutton actuator for flush mounting
page 308, 320

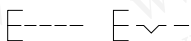

35 potentiometer-drive, potentiometer-drive for flush mounting
page 308, 321



36 slow-make switching element stackable for front mounting, slow-make switching element not stackable for front mounting, slow-make switching element not stackable for base mounting
page 327, 327, 328

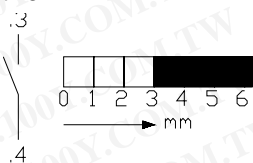

37 slow-make switching element stackable for front mounting
page 327

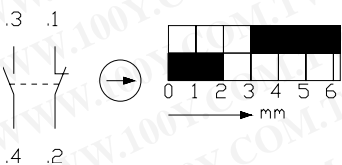

38 slow-make switching element stackable for front mounting, slow-make switching element not stackable for front mounting, slow-make switching element not stackable for base mounting
page 327, 327, 328

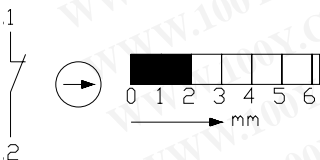

39 slow-make switching element stackable for front mounting
page 327

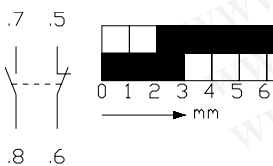

Switching examples for the central lamp test

Application of the diode element with 1 diode

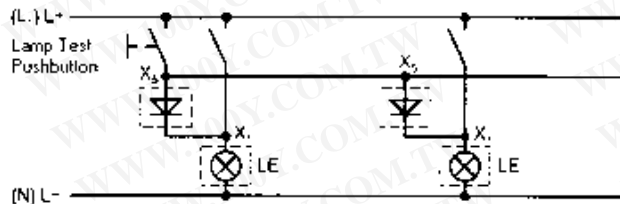

Application of the diode element with 2 diodes

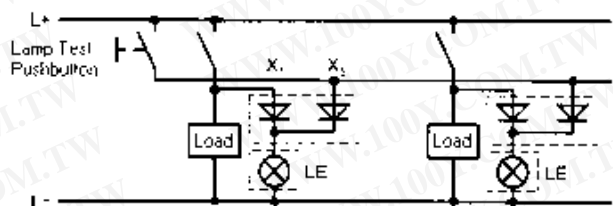

Application of the diode resistance element with lamp test

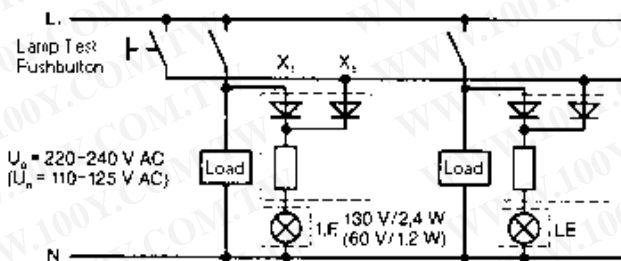

Note:

- Only apply incandescent lamps with special data!
Incandescent lamp 130V/2,4 W with spiral form 2 x CC-2F; Typ-N44-952.130
Incandescent lamp 60 V/1,2 W with spiral form CC-2F; Typ-N44-952.60
- maximum environmental temperature 40°C for Part-Nr. 44-614.11 und 44-614.21
- For base mounting the connection wire which juts out in the middle must be placed so that it does not interfere with the actuator system.





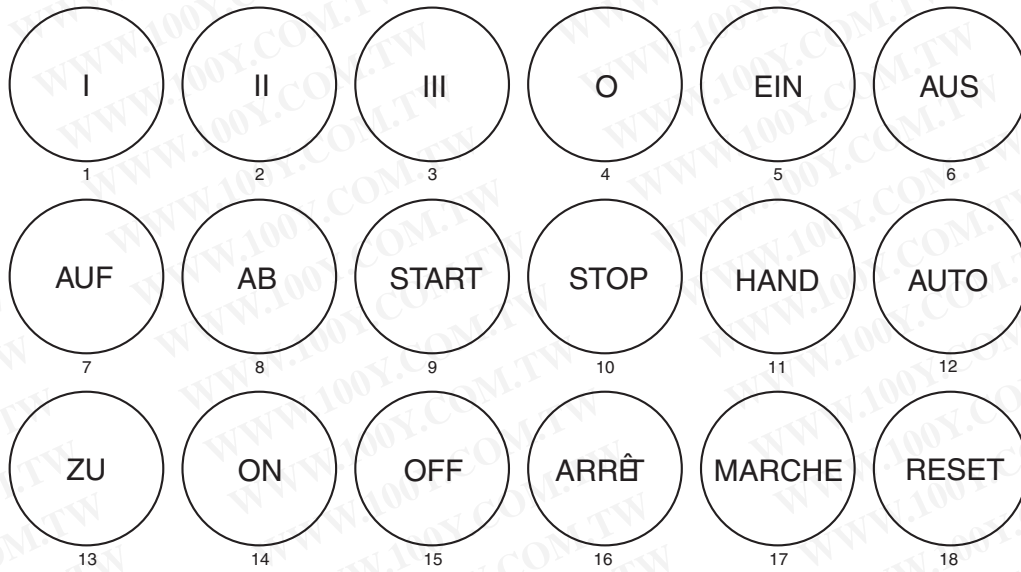























































Standard texts for text plates

Text-Nr.



Symbols as per ISO R 369 for text plates

Symbol No.

	1	Direction of linear rectilinear motion (also for $\rightarrow \downarrow \uparrow$)		13	Direction of spindle rotation		29	Decrease of value (speed, for instance)		49	Cooling pump
	2	Linear motion in in 2 directions (also for \downarrow)		14	One revolution		30	Speed of planing cut		50	Lubricant pump
	3	Interrupted linear motion (also for $\leftarrow \downarrow \uparrow$)		15	Number of revolutions per minute (spindle speed)		31	Speed of turning cut		51	Hydraulic system pump
	4	Limited linear motion (also for $\leftarrow \downarrow \uparrow$)		16	Feed		32	Speed of drilling cut		52	Hydraulic motor
	5	Limited linear motion and return		17	Feed per revolution		33	Speed of milling cut (similar symbol for speed of grinding)		53	Tracer
	6	Oscillating linear motion (continuous)		18	Feed per minute		34	Conventional milling		61	Stepless regulation
	7	Direction of continuous rotation (right)		19	Reduced feed		35	Climb milling (down milling)		62	Adjustable
	7a	Direction of continuous rotation (left)		20	Rapid feed		41	Electric motor		63.1	Look or tighten
	8	Rotation in 2 directions		21	Normal feed		42	Rectangular work table or slide element		63.2	Look or tighten
	9	Direction of interrupted rotation (right)		22	Direction of feed (orientation not specified)		43	Round work table or rotating element		64.1	Unlock, unclamp
	9a	Direction of interrupted rotation (left)		24	Transverse feed		44	Turning spindle		64.2	Chuck open
	10	Limited rotation (right)		25	Vertical feed		45	Drilling spindle		65	Brake on
	10a	Limited rotation (left)		26	Rapid traverse		46	Milling spindle		66	Brake off
	11	Limited rotation and return		27	Threading		47	Grinding spindle		67	Automatic (or semi-automatic) cycle
	12	Oscillating rotary movement (continuous)		28	Increase of value (speed, for instance)		48	Pump (general symbol)		68	Hand control



Symbols as per ISO R 369 for textplates

Symbol No.

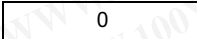
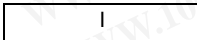

Marking for labels

label black anodized

Text-No.	Text-No.	Text-No.
 T 01	Forwards T 14	Set up T 22
 T 02	Reverse T 15	Raise T 23
 T 03	Right T 16	Lower T 24
 T 04	Left T 17	Hand T 25
OFF T 10	Halt T 18	STOP T 26
ON T 11	Close T 19	START T 27
Up T 12	Fast T 20	HAND/AUTO T 28
Down T 13	Slow T 21	OFF/ON T 29

勝特力材料 886-3-5753170
勝特力电子(上海) 86-21-54151736
勝特力电子(深圳) 86-755-83298787
[Http://www.100y.com.tw](http://www.100y.com.tw)

EAO AG
Tannwaldstrasse 88
4601 Olten, Switzerland

E-mail info@eao.com
Website www.eao.com

Belgium
Phone +32/2 456 00 10
E-mail sales.ebl@eao.com

China
Phone +852/27 86 91 41
E-mail sales.ehk@eao.com.hk

France
Phone +33/1 64 43 37 37
E-mail sales.es@eao.com

Germany
Phone +49/201 85 87 0
E-mail sales.ede@eao.com

Japan
Phone +81/3 5401 0953
E-mail sales.esj@eao.com

Netherlands
Phone +31/78 653 17 00
E-mail sales.enl@eao.com

Sweden
Phone +46/8 683 86 60
E-mail sales.esw@eao.com

Switzerland
Phone +41/62 388 95 00
E-mail sales.ech@eao.com

United Kingdom
Phone +44/1444 236000
E-mail sales.euk@eao.com

USA
Phone +1/203 877 4577
E-mail sales.eus@eao.com

Other Countries
Fax +41/62 296 21 62
E-mail info@eao.com
Website www.eao.com

eao 